

SAMSUNG

EHS

Technical Data Book

EHS Split for Europe
(R410A, 50Hz, HP)



Model : Outdoor unit (AE***AXED*H/EU)
Hydro unit (AE***ANYD*H/EU)

History

Version	Modification	Date	Remark
Ver.1.0	Released EHS Split for Europe TDB (R410A, 50Hz, HP)	21.04.14	
Ver.1.1	Updated the dimensional drawing page	21.04.21	

Nomenclature

Outdoor Unit

Model Name

AE	160	A	X	E	D	E	H	/	EU
(1)	(2)	(3)	(4)	(5)	(6)	(7)	(8)		Buyer

(1) Classification

AC	CAC
AM	DVM
AJ	FJM (Free Joint Multi)
AE	EHS

(2) Capacity

X1/10 kW (3 digits)

(3) Version

A	2021
---	------

(4) Product Type

S	SET (NASA)
N	Indoor Unit (NASA)
X	Outdoor Unit (NASA)
A	SET (Non NASA)
B	Indoor Unit (Non NASA)
C	Outdoor Unit (Non NASA)

(5) Feature 1

E	Split
T	TDM
Y	MONO

(6) Feature 2

D	Deluxe
P	Premium

(7) Rating Voltage

A	115V, 60hz, 1Φ
B	220V, 60Hz, 1Φ
C	208~230V, 60Hz, 1Φ
D	200~220V, 50Hz, 1Φ
E	220~240V, 50Hz, 1Φ
F	208~230V, 60Hz, 3Φ
G	380~415V, 50Hz, 3Φ

(8) Mode

H	Heat Pump (R410A)
---	-------------------

Nomenclature

Hydro unit

Model Name

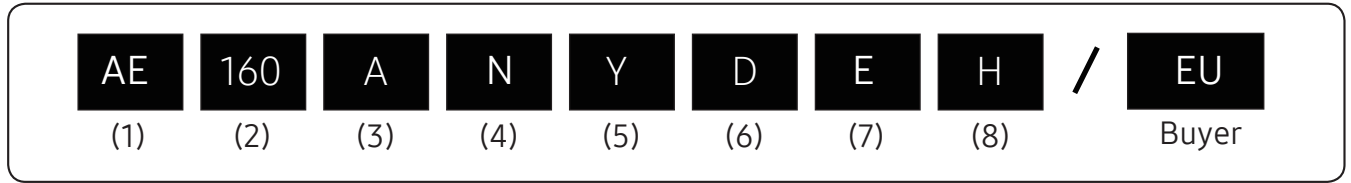

(1) Classification

AC	CAC
AM	DVM
AJ	FJM (Free Joint Multi)
AE	EHS

(2) Capacity

	x Liter (3 digits)
--	--------------------

(3) Version

A	2021
---	------

(4) Product Type

S	SET (NASA)
N	Indoor Unit (NASA)
X	Outdoor Unit (NASA)
A	SET (Non NASA)
B	Indoor Unit (Non NASA)
C	Outdoor Unit (Non NASA)

(5) Product Notation

Y	Hydro Unit (Wall Mounted)
---	---------------------------

(6) Feature

D	Standard
---	----------

(7) Rating Voltage

A	115V, 60hz, 1Φ
B	220V, 60Hz, 1Φ
C	208~230V, 60Hz, 1Φ
D	200~220V, 50Hz, 1Φ
E	220~240V, 50Hz, 1Φ
F	208~230V, 60Hz, 3Φ
G	380~415V, 50Hz, 3Φ

(8) Mode

H	Heat Pump (R410A)
---	-------------------

Features & Benefits

Overview

Optimized Seasonal Efficiency

EHS Split delivers efficient performance in all seasons. Heating performance is optimized according to the actual operating temperature. It provides outstanding efficiency with ECO-friendly design.



Flexibility

EHS split is a versatile system with under floor heating, hot water and radiator. Our Hydro Unit can be compatible with a wide range of additional products such as thermostats, solar panels and back-up boilers.

High Reliability

EHS Split includes a number of improvements that together create superior performance. The low-noise fan and Silent Mode at night ensure a meaningful presence. Our EHS system creates the perfect living condition.





Contents



1. Line-up	7
1-1. Outdoor Units	7
1-2. Hydro unit	7
2. Outdoor Units	8
2-1. Specifications	8
2-2. Electrical characteristics	12
2-3. Dimensional drawing	13
2-4. Electrical wiring diagram	14
2-5. Sound data	16
2-6. Operation range	18
2-7. Piping diagram	19
2-8. Capacity table	20
2-9. Capacity correction	22
3. Hydro unit	23
3-1. Specifications	23
3-2. Dimensional drawing	24
3-3. Electrical wiring diagram	25
3-4. Sound data	27
3-5. Piping diagram	29
4. Installation	30
Hydro unit	30
Outdoor Unit	43

1. Line-up

1-1. Outdoor Units

Capacity		12 kW	16 kW
Image			
Model	1phase	AE120AXEDEH/EU	AE160AXEDEH/EU
	3phase	AE120AXEDGH/EU	AE160AXEDGH/EU

1-2. Hydro unit

	1phase	3phase
Model	AE160ANYDEH/EU	AE160ANYDGH/EU
Hydro Unit		

2. Outdoor Units

2-1. Specifications

Model Name	Indoor Unit			AE160ANYDEH/EU	AE160ANYDEH/EU	
	Outdoor Unit			AE120AXEDEH/EU	AE160AXEDEH/EU	
System	Mode			-	Heat Pump (A2W)	Heat Pump (A2W)
	Performance (A7/W35) *1	Nominal Capacity	Heating	W	12,000	16,000
				Btu/h	40,900	54,600
			Cooling	W	12,000	15,000
				Btu/h	40,900	51,200
		Power Input (Nominal)	Heating	W	2,590	3,760
					Cooling	3,100
		Current Input (Nominal)	Heating	A	11.70	16.90
					Cooling	14.00
	COP (Nominal Heating)			W/W	4.63	4.26
	EER (Nominal Cooling)			W/W	3.87	3.62
	Eco design	35°C	P-design H	W	13.00	14.00
			SCOP	W/W	4.59	4.46
			GRADE	-	A+++	A+++
		55°C	P-design H	W	12.50	14.00
			SCOP	W/W	3.12	3.09
			GRADE	-	A+	A+
	SEER			-	4.45	4.39
	Performance (A7/W45) *2	Capacity	Heating	W	11,500	15,300
		COP		W/W	3.56	3.37
	Performance (A7/W55) *3	Capacity	Heating	W	11,000	14,600
		COP		W/W	2.89	2.74
	Performance (A2/W35) *4	Capacity	Heating	W	11000	13700
		COP		W/W	3.48	3.26
	Performance (A-7/W35) *5	Capacity	Heating	W	11,300	13,800
		COP		W/W	2.76	2.53
	Performance (A35/W7) *6	Capacity	Cooling	W	9,000	11,200
		EER		W/W	2.90	2.80
	Field	MCA		A	28.0	32.0
	Wiring	MFA		A	35.0	40.0
	Water Connections	Water Flow		LPM	35/35	46/44
		Water Pressure (Max)		bar	3	3
Water Pipe		Inlet	Φ, inch	BSPP male 1 1/4"	BSPP male 1 1/4"	
		Outlet	Φ, inch	BSPP male 1 1/4"	BSPP male 1 1/4"	
Leaving Water		Heating	°C	15~55	15~55	
	Cooling	°C	5~25	5~25		
Refrigerant Connections	Liquid Pipe		Φ, mm	9.52	9.52	
			Φ, inch	3/8	3/8	
	Gas Pipe		Φ, mm	15.88	15.88	
			Φ, inch	5/8	5/8	
	Installation Limitation	Max. Length		m	50	50
		Max. Height		m	30	30
Chargeless Length			m	15	15	
Operating Temp. Range	Heating (A2W) *7		°C	-25~35	-25~35	
	Cooling (A2W)		°C	10~46	10~46	
	DHW (A2W) *8		°C	-25~43	-25~43	

2. Outdoor Units

2-1. Specifications

Model Name	Indoor Unit			AE160ANYDEH/EU	AE160ANYDEH/EU	
	Outdoor Unit			AE120AXEDEH/EU	AE160AXEDEH/EU	
Outdoor Unit	Power Supply		V, Hz, Φ	220~240, 50, 1	220~240, 50, 1	
	Compressor	Type	-	BLDC Twin Rotary	BLDC Twin Rotary	
		Model	-	UG5TK5450FJX	UG5TK5450FJX	
		Oil Type	-	PVE	PVE	
	Condenser	Size	-	2RX66S	2RX66S	
		Motor	Type (Model)	-	FMDC531SSA	FMDC531SSA
	Quantity		EA	2	2	
	CODE No		-	DB31-00579A	DB31-00579A	
	Fan	Air Flow Rate	Cooling	CMM	99	118
		Number of Unit		EA	2	2
	4-Way Valve	Type (Model)			SHF-20D-46	SHF-20D-46
	Base Heater	Power Input		W	150	150
	Sound *9	Sound	Cooling	dB(A)	50	54
			Heating	dB(A)	50	52
		Power	Cooling	dB(A)	64	69
			Heating	dB(A)	64	66
	External Dimension	Net Weight		kg	100.5	100.5
		Shipping Weight		kg	110.0	110.0
		Net Dimensions (WxHxD)		mm	940 x 1,420 x 330	940 x 1,420 x 330
		Shipping Dimensions (WxHxD)		mm	995 x 1,598 x 426	995 x 1,598 x 426
Refrigerant	Type		-	R410A	R410A	
	Control Method		-	EEV	EEV	
	Factory Charging *10		g / tCO ₂ e	2,980	2,980	

NOTE

- Specifications may be subject to change without prior notice.
 - *1) A2W Condition *1 : (Heating) Water In/Out 30°C/35°C, Outdoor Air 7°CDB/6°CWB;
(Cooling) Water In/Out 23°C/18°C, Outdoor Air 35°CDB.
 - *2) A2W Condition *2 : (Heating) Water In/Out 40°C/45°C, Outdoor Air 7°CDB
 - *3) A2W Condition *3 : (Heating) Water In/Out 47°C/55°C, Outdoor Air 7°CDB
 - *4) A2W Condition *4 : (Heating) Water In/Out 30°C/35°C, Outdoor Air 2°CDB
 - *5) A2W Condition *5 : (Heating) Water In/Out 30°C/35°C, Outdoor Air -7°CDB
 - *6) A2W Condition *6 : (Cooling) Water In/Out 12°C/7°C, Outdoor Air 35°CDB
 - *7) The system is operated in (-25°C ≤ Outdoor temp. < -20°C) condition, but no guarantee of capacity.
 - *8) The system is operated by only Booster Heater in special condition (35 °C < Outdoor temp. ≤ 43°C).
- *9) Sound pressure level is obtained in an anechoic room.
 - Sound pressure level is a relative value, depending on the distance and acoustic environment.
 - Sound pressure level may differ depending on operation condition.
 - Sound pressure level in Night Mode is measured 3m away from front side of outdoor unit.
 - dBA = A-weighted sound pressure level
 - Reference acoustic pressure 0 dB = 20uPa

Sound power level is an absolute value that a sound source generates.

 - dBA = A-weighted Sound power level
 - Reference power : 1pW
 - Measured according to ISO 3741
- Select wire size based on the value of MCA
- These products contain R32 (GWP=675) which is fluorinated greenhouse gas.

2. Outdoor Units

2-1. Specifications

Model Name	Indoor Unit			AE160ANYDGH/EU	AE160ANYDGH/EU	
	Outdoor Unit			AE120AXEDGH/EU	AE160AXEDGH/EU	
System	Mode			-	Heat Pump (A2W)	Heat Pump (A2W)
	Performance (A7/W35) *1	Nominal Capacity	Heating	W	12,000	16,000
				Btu/h	40,900	54,600
			Cooling	W	12,000	15,000
				Btu/h	40,900	51,200
		Power Input (Nominal)	Heating	W	2,590	3,760
					Cooling	3,100
		Current Input (Nominal)	Heating	A	4.10	5.70
					Cooling	4.70
	COP (Nominal Heating)			W/W	4.63	4.26
	EER (Nominal Cooling)			W/W	3.87	3.62
	Eco design	35°C	P-design H	W	13.00	14.00
			SCOP	W/W	4.59	4.46
			GRADE	-	A+++	A+++
		55°C	P-design H	W	12.50	14.00
			SCOP	W/W	3.12	3.09
			GRADE	-	A+	A+
	SEER			-	4.45	4.39
	Performance (A7/W45) *2	Capacity	Heating	W	11,500	15,300
		COP		W/W	3.56	3.37
	Performance (A7/W55) *3	Capacity	Heating	W	11,000	14,600
		COP		W/W	2.89	2.74
	Performance (A2/W35) *4	Capacity	Heating	W	11000	13700
		COP		W/W	3.48	3.26
	Performance (A-7/W35) *5	Capacity	Heating	W	11,300	13,800
		COP		W/W	2.76	2.53
	Performance (A35/W7) *6	Capacity	Cooling	W	9,000	11,200
		EER		W/W	2.90	2.80
	Field	MCA		A	10.0	12.0
	Wiring	MFA		A	16.1	16.1
	Water Connections	Water Flow		LPM	35/35	46/44
		Water Pressure (Max)		bar	3	3
		Water Pipe	Inlet	Φ, inch	BSPP male 1 1/4"	BSPP male 1 1/4"
			Outlet	Φ, inch	BSPP male 1 1/4"	BSPP male 1 1/4"
		Leaving Water	Heating	°C	15~55	15~55
	Cooling		°C	5~25	5~25	
	Refrigerant Connections	Liquid Pipe		Φ, mm	9.52	9.52
				Φ, inch	3/8	3/8
		Gas Pipe		Φ, mm	15.88	15.88
				Φ, inch	5/8	5/8
Installation Limitation		Max. Length	m	50	50	
	Max. Height	m	30	30		
Chargeless Length			m	15	15	
Operating Temp. Range	Heating (A2W) *7		°C	-25~35	-25~35	
	Cooling (A2W)		°C	10~46	10~46	
	DHW (A2W) *8		°C	-25~43	-25~43	

2. Outdoor Units

2-1. Specifications

Model Name	Indoor Unit			AE160ANYDGH/EU	AE160ANYDGH/EU	
	Outdoor Unit			AE120AXEDGH/EU	AE160AXEDGH/EU	
Outdoor Unit	Power Supply		V, Hz, Φ	380~415, 50, 3	380~415, 50, 3	
	Compressor	Type	-	BLDC Twin Rotary	BLDC Twin Rotary	
		Model	-	UG5TK5450FJX	UG5TK5450FJX	
		Oil Type	-	PVE	PVE	
	Condenser	Size	-	2RX66S	2RX66S	
		Type (Model)	-	FMDC531SSA	FMDC531SSA	
	Motor	Quantity	EA	2	2	
		CODE No	-	DB31-00579A	DB31-00579A	
	Fan	Air Flow Rate	Cooling	CMM	99	118
		Number of Unit		EA	2	2
	4-Way Valve	Type (Model)		SHF-20D-46	SHF-20D-46	
	Base Heater	Power Input		W	150	150
	Sound *9	Sound	Cooling	dB(A)	50	54
			Heating	dB(A)	50	52
		Pressure	Cooling	dB(A)	64	69
			Heating	dB(A)	64	66
	External Dimension	Net Weight		kg	99.5	99.5
		Shipping Weight		kg	109.0	109.0
		Net Dimensions (WxHxD)		mm	940 x 1,420 x 330	940 x 1,420 x 330
		Shipping Dimensions (WxHxD)		mm	995 x 1,598 x 426	995 x 1,598 x 426
Refrigerant	Type		-	R410A	R410A	
	Control Method		-	EEV	EEV	
	Factory Charging *10		g / tCO ₂ e	2,980	2,980	

NOTE

- Specifications may be subject to change without prior notice.
 - *1) A2W Condition *1 : (Heating) Water In/Out 30°C/35°C, Outdoor Air 7°CDB/6°CWB;
(Cooling) Water In/Out 23°C/18°C, Outdoor Air 35°CDB.
 - *2) A2W Condition *2 : (Heating) Water In/Out 40°C/45°C, Outdoor Air 7°CDB
 - *3) A2W Condition *3 : (Heating) Water In/Out 47°C/55°C, Outdoor Air 7°CDB
 - *4) A2W Condition *4 : (Heating) Water In/Out 30°C/35°C, Outdoor Air 2°CDB
 - *5) A2W Condition *5 : (Heating) Water In/Out 30°C/35°C, Outdoor Air -7°CDB
 - *6) A2W Condition *6 : (Cooling) Water In/Out 12°C/7°C, Outdoor Air 35°CDB
 - *7) The system is operated in (-25°C ≤ Outdoor temp. < -20°C) condition, but no guarantee of capacity.
 - *8) The system is operated by only Booster Heater in special condition (35 °C < Outdoor temp. ≤ 43°C).
- *9) Sound pressure level is obtained in an anechoic room.
 - Sound pressure level is a relative value, depending on the distance and acoustic environment.
 - Sound pressure level may differ depending on operation condition.
 - Sound pressure level in Night Mode is measured 3m away from front side of outdoor unit.
 - dBA = A-weighted sound pressure level
 - Reference acoustic pressure 0 dB = 20uPa

Sound power level is an absolute value that a sound source generates.

 - dBA = A-weighted Sound power level
 - Reference power : 1pW
 - Measured according to ISO 3741
- Select wire size based on the value of MCA
- These products contain R32 (GWP=675) which is fluorinated greenhouse gas.

2. Outdoor Units

2-2. Electrical characteristics

Capacity [kW]	Model	Power Supply				Voltage Range [V]		Nominal Running Current [A]		Current [A]	
		Φ	#	Hz	Voltage	Min. (-10%)	Max. (+10%)	Cooling	Heating	MCA	MFA
12	AE120AXEDEH/EU	1	2	50	220~240	198	264	14.0	11.7	28.0	35.0
12	AE120AXEDGH/EU	3	4	50	380~415	342	456	4.7	4.1	10.0	16.1
16	AE160AXEDEH/EU	1	2	50	220~240	198	264	18.6	16.9	32.0	400
16	AE160AXEDGH/EU	3	4	50	380~415	342	456	6.2	5.7	12.0	16.1

NOTE

- MCA : Minimum circuit amperes
- MFA : Maximum fuse amperes
- Select wire size based on the value of MCA

2. Outdoor Units

2-3. Dimensional drawing

Unit : mm

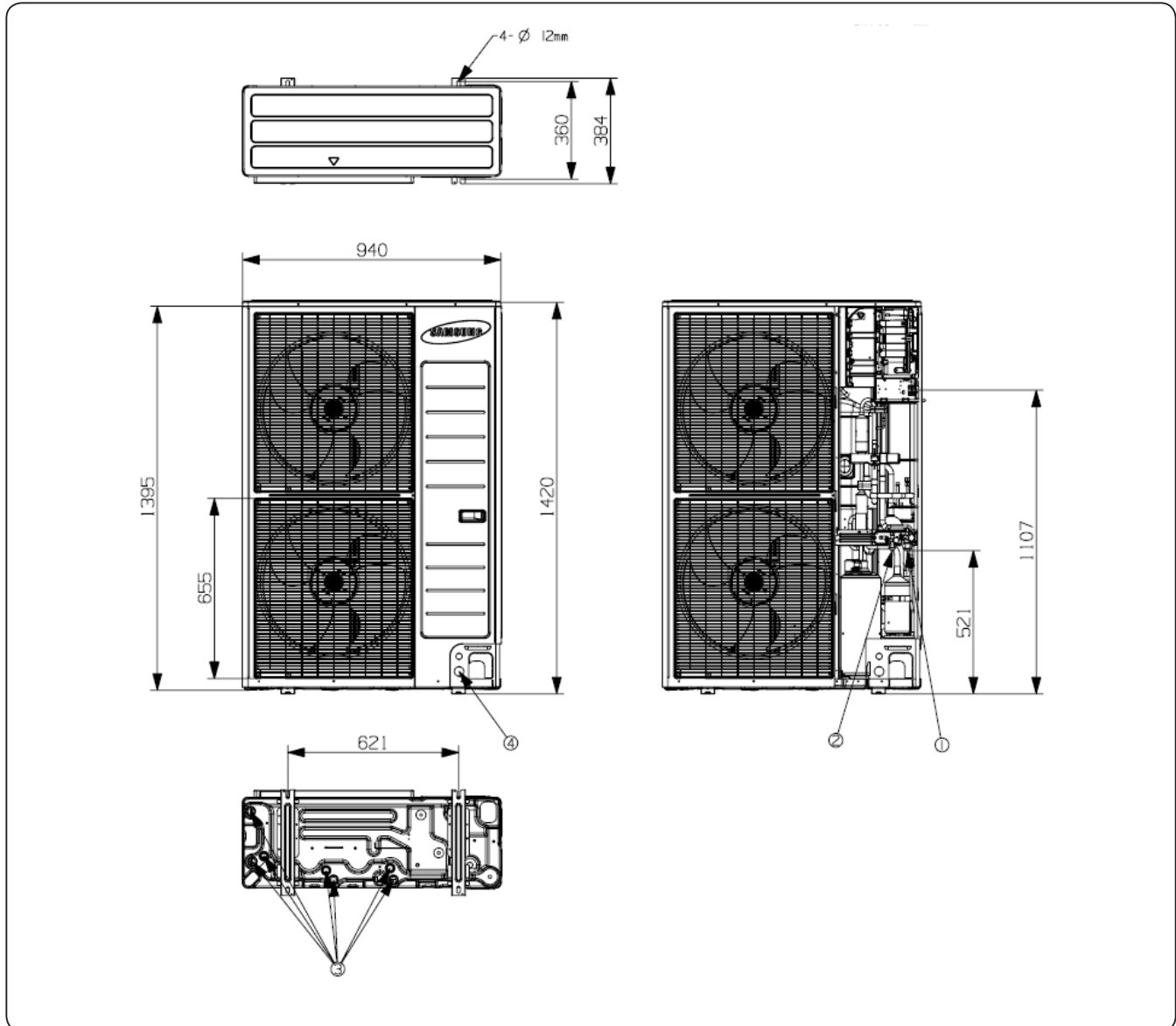

NO	Name	Description
1	Gas Ref. Pipe	Φ15.88(5/8")
2	Liquid Ref. Pipe	Φ9.52(3/8")
3	Drain Hole	Connect with the provided drain plug.
4	Power & Communication Wiring Conduits	-

2. Outdoor Units

2-4. Electrical wiring diagram

AE120AXEDEH/EU, AE160AXEDEH/EU

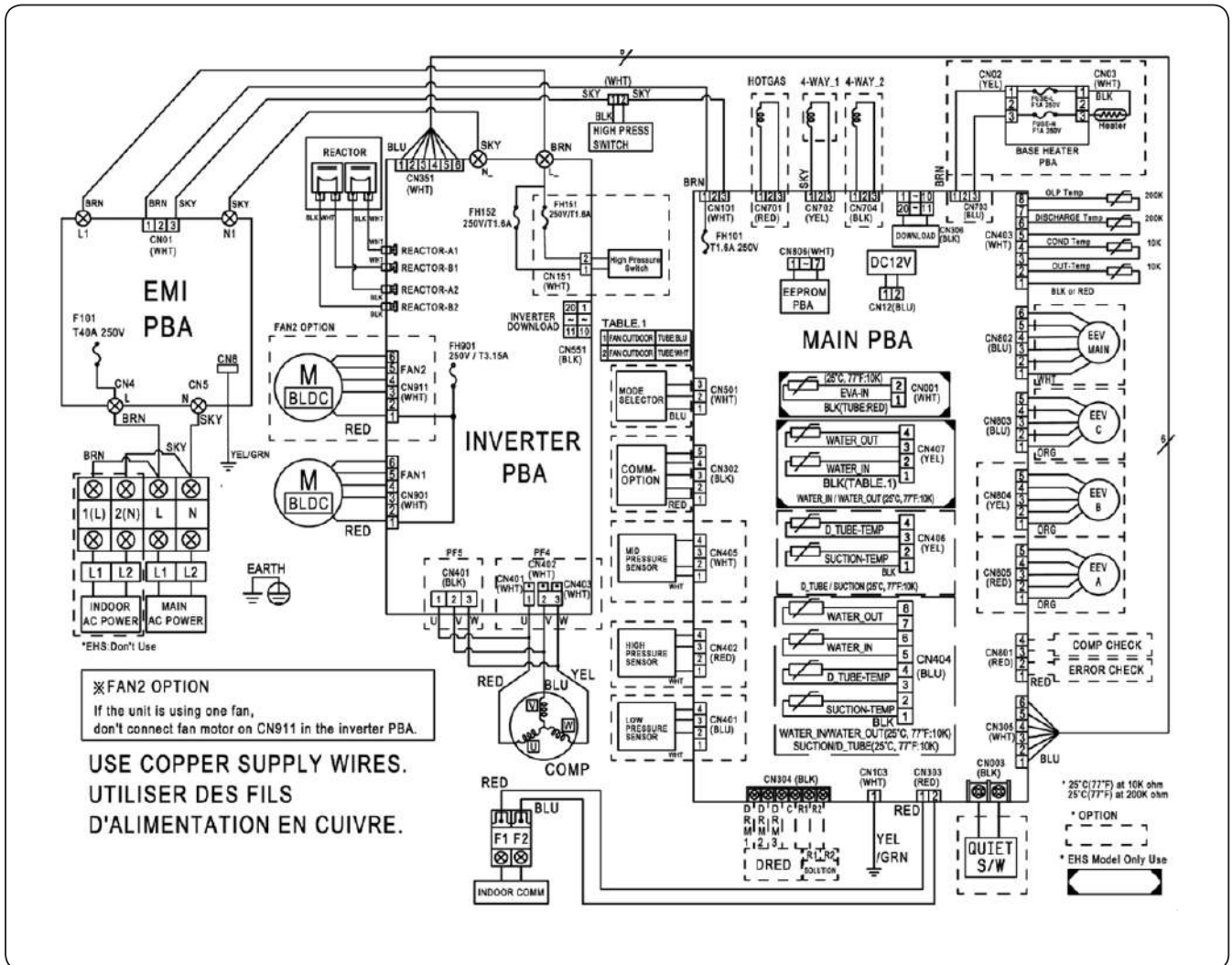

MAIN PBA	Printed circuit board(MAIN)	INVERTER PBA	Printed circuit board(INVERTER)
EMI PBA	Printed circuit board(EMI)	M BLDC	Motor for Outdoor Fan
EEV	Electronic expansion valve	COMP	Compressor
OUT-TEMP	Thermistor - Ambient	COND-TEMP	Thermistor - Cond
DISCHARGE-TEMP	Thermistor - Discharge pipe	OLP-TEMP	Thermistor - OLP
SUCTON-TEMP	Thermistor - Suction pipe	D_TUBE-TEMP	Thermistor - D_tube
WATER_OUT	Thermistor - Water Out	WATER_IN	Thermistor - Water In

NOTE

1. This wiring diagram applies only to the Outdoor unit.
2. Symbols show as follow :
 blk: black, red: red, blu: blue, wht: white, yel: yellow, brn: brown, sky: skyblue, grn: green
3. For connection wiring indoor-outdoor transmission F1-F2, indoor-wired remote controller transmission F3-F4.
4. Protective earth(SCREW)

2. Outdoor Units

2-4. Electrical wiring diagram

AE120AXEDGH/EU, AE160AXEDGH/EU

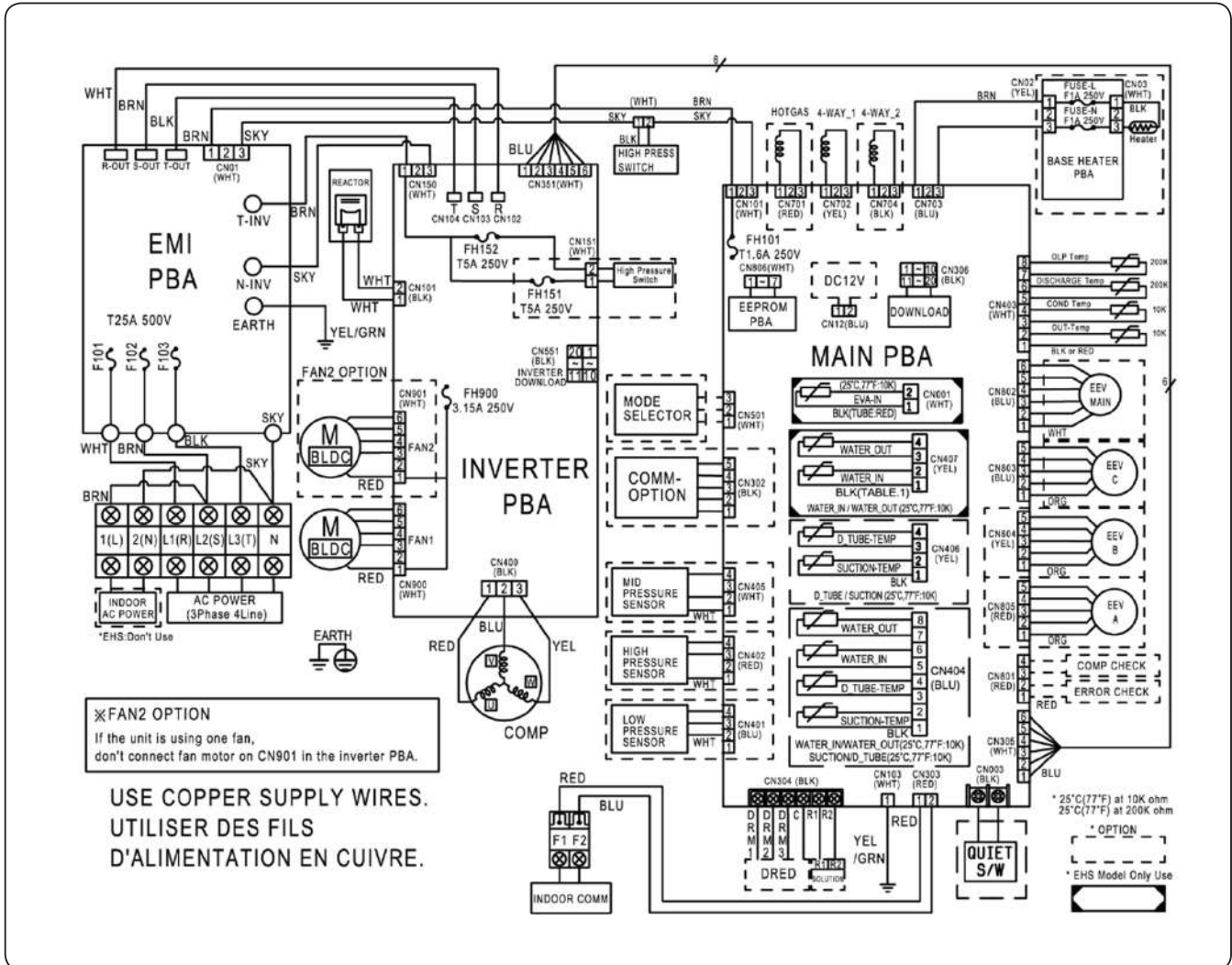

MAIN PBA	Printed circuit board(MAIN)	INVERTER PBA	Printed circuit board(INVERTER)
EMI PBA	Printed circuit board(EMI)	M BLDC	Motor for Outdoor Fan
EEV	Electronic expansion valve	COMP	Compressor
OUT-TEMP	Thermistor - Ambient	COND-TEMP	Thermistor - Cond
DISCHARGE-TEMP	Thermistor - Discharge pipe	OLP-TEMP	Thermistor - OLP
SUCTION-TEMP	Thermistor - Suction pipe	D_TUBE-TEMP	Thermistor - D_tube
WATER_OUT	Thermistor - Water Out	WATER_IN	Thermistor - Water In

NOTE

1. This wiring diagram applies only to the Outdoor unit.
2. Symbols show as follow :
 blk: black, red: red, blu: blue, wht: white, yel: yellow, brn: brown, sky: skyblue, grn: green
3. For connection wiring indoor-outdoor transmission F1-F2, indoor-wired remote controller transmission F3-F4.
4. ⚡ Protective earth(SCREW)

2. Outdoor Units

2-5. Sound data

Sound Pressure level

Unit: dB(A)

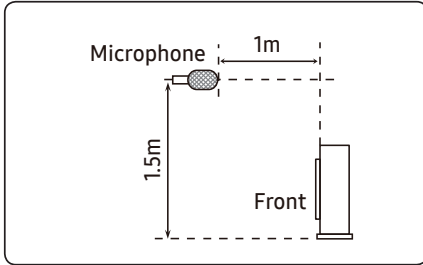

Model	Cooling	Heating
AE120AXEDEH/EU	50	50
AE120AXEDGH/EU	50	50
AE160AXEDEH/EU	54	52
AE160AXEDGH/EU	54	52

- NR Curve

1) AE120AXEDEH/EU

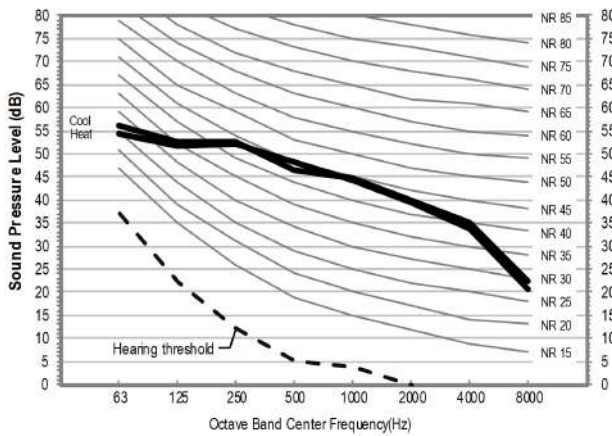

2) AE120AXEDGH/EU

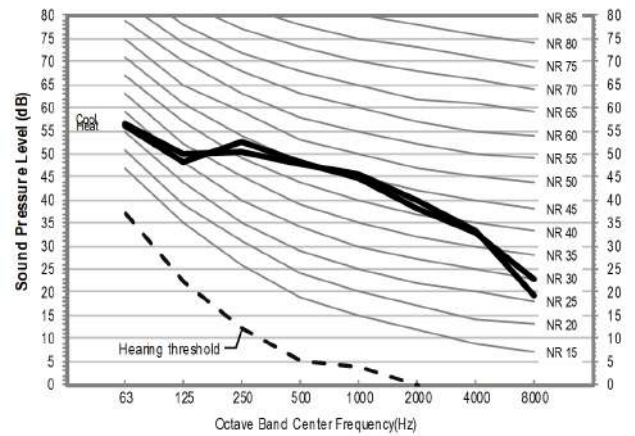

3) AE160AXEDEH/EU

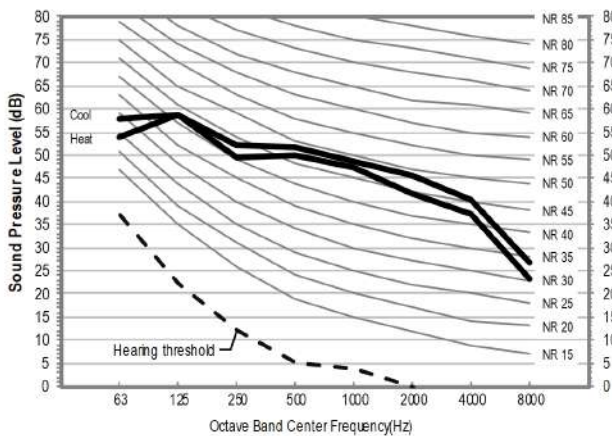

4) AE160AXEDGH/EU

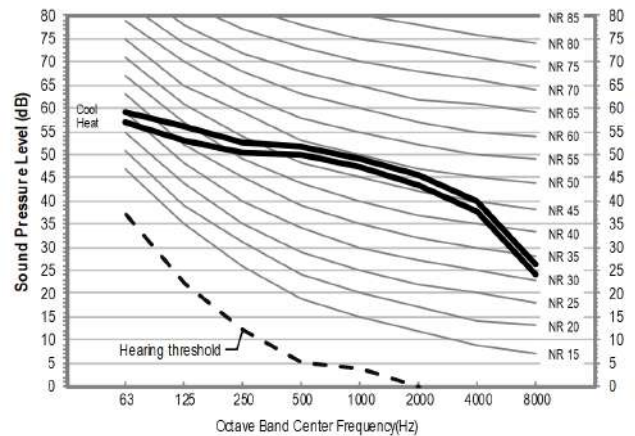

2. Outdoor Units

2-5. Sound data

Sound Power level

NOTE

- Specifications may be subject to change without prior notice
 - Sound power level is an absolute value that a sound source generates.
 - dBA = A-weighted sound power level.
 - Reference power : 1pW.
 - Measured according to ISO 3741.

Model	Power (dBA)
AE120AXEDEH/EU	64
AE120AXEDGH/EU	64
AE160AXEDEH/EU	66
AE160AXEDGH/EU	66

1) AE120AXEDEH/EU

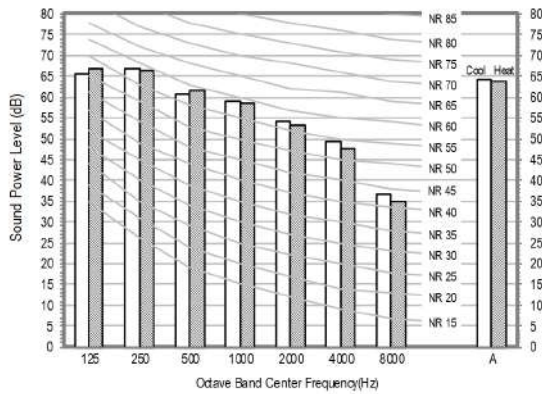

2) AE120AXEDGH/EU

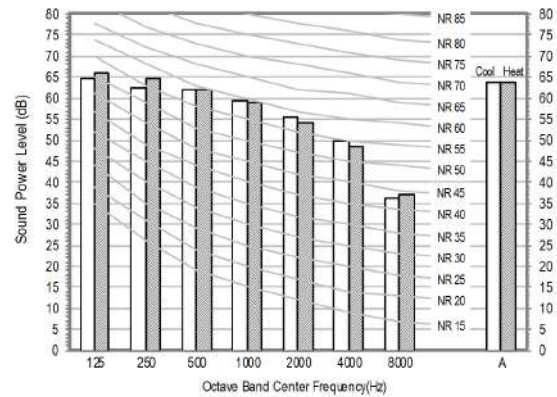

3) AE160AXEDEH/EU

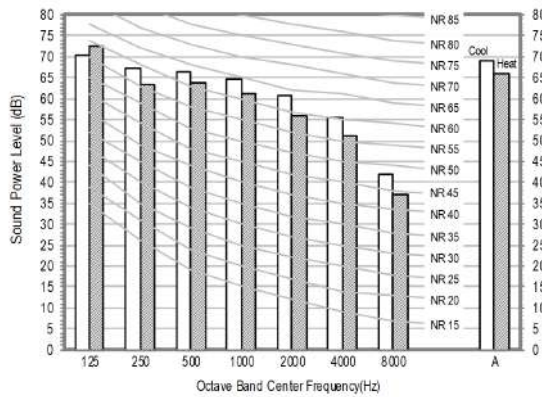

4) AE160AXEDGH/EU

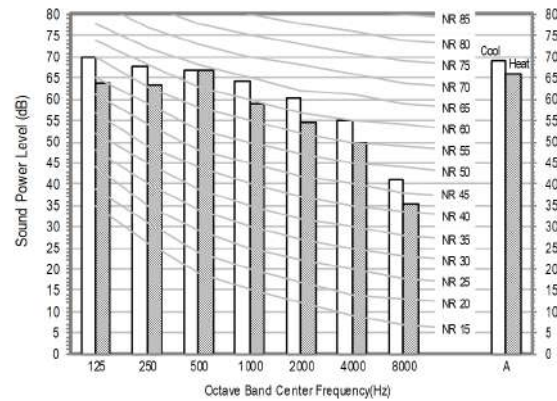

2. Outdoor Units

2-6. Operation range

1) Cooling

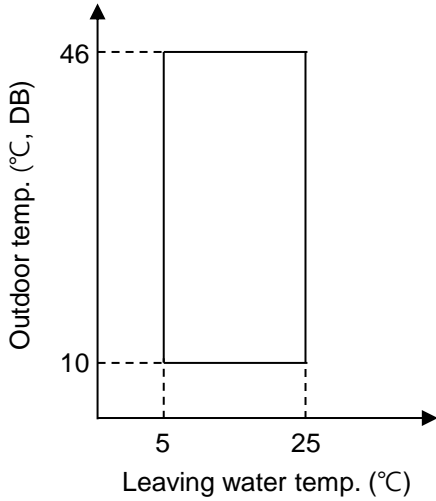

2) Heating

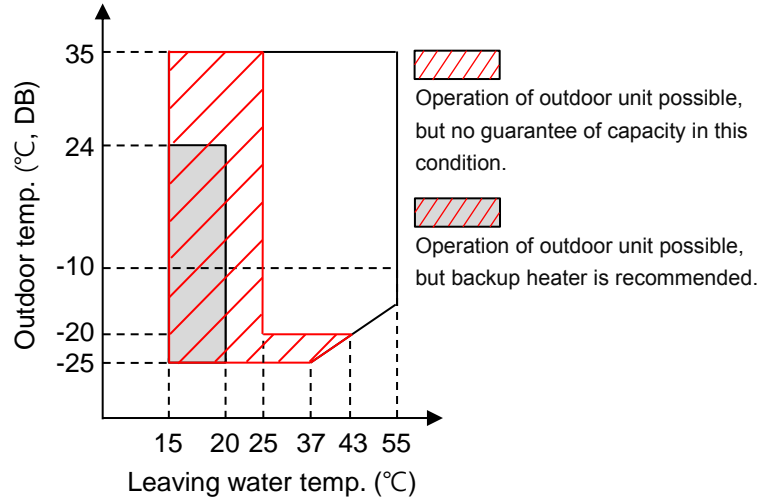

MONO Outdoor Unit		Water Temp. (°C)			Water Flow Rates (LPM)			Air Temp. (°C, DB/WB)		
		Min	Std	Max	Min	Std	Max	Min	Std	Max
Controller	Cooling	5	-	25	12			10/-		
	Heating	15	-	55						
Cooling	Inlet	-	23 (12 ^{*1})	30	12	Δ 5°C	58	35/24	46/28	-25/-
	Outlet	5	18 (7 ^{*1})	25						
Heating	Inlet	5	30 (40 ^{*1})	-	7/6 (-7/-8 ^{*2})			35/24		
	Outlet	25 (15 ^{*3})	35 (45 ^{*1})	55						

*1) Eurovent Test Condition #2

*2) NF PAC Low Temp. Heating Condition.

*3) Back up heater operation.

3) DHW (Domestic Hot Water Tank)

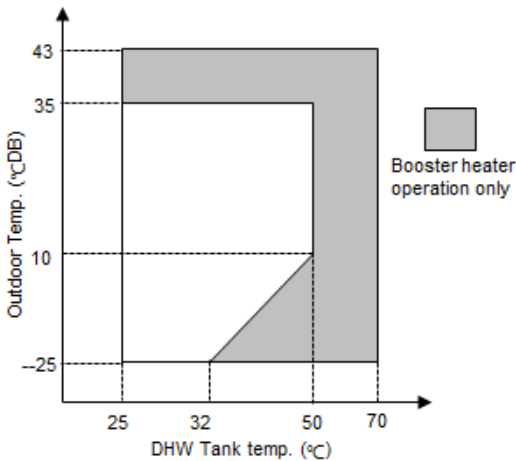

* Special condition (35°C < Outdoor temp. ≤ 43°C) is operated by only Booster Heater.
 SAMSUNG doesn't supply DHW for EHS Split.
 Since it is a reference data, you have to check DHW operation range for yours.

2. Outdoor Units

2-7. Piping diagram

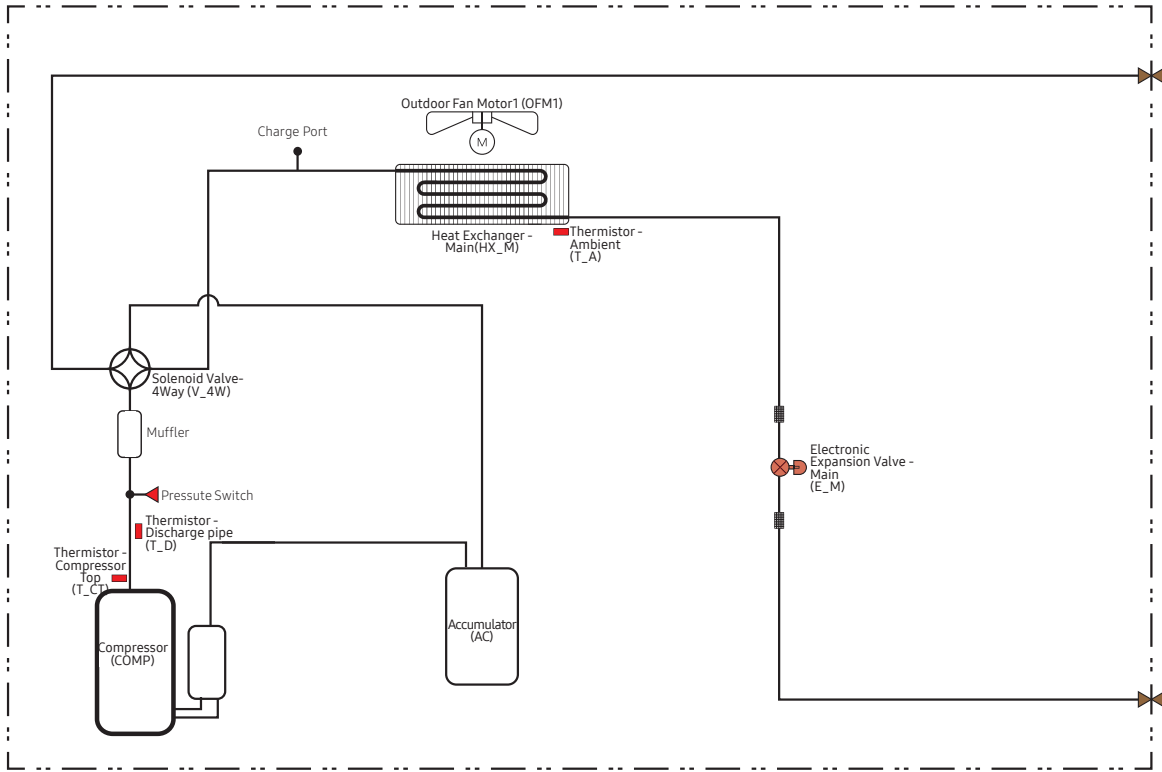

2. Outdoor Units

2-8. Capacity table

1) Maximum Heating Capacity

LWT (Leaving Water Temp.), Tamb (Ambient Temp.), HC (Heating Capacity), PI (Power input)

AE120AXED*H/EU

LWT(°C)	25		30		35		40		45		50		55	
Tamb(°C)	HC(kW)	PI(kW)	HC(kW)	PI(kW)	HC(kW)	PI(kW)	HC(kW)	PI(kW)	HC(kW)	PI(kW)	HC(kW)	PI(kW)	HC(kW)	PI(kW)
-25	8.26	3.93	8.03	4.21	7.58	4.45	7.26	4.42						
-20	9.58	3.69	9.32	3.95	8.95	4.26	8.61	4.39	8.26	4.56				
-15	10.19	3.90	9.91	4.17	9.44	4.51	8.97	4.61	8.50	4.61	7.54	4.83		
-10	9.65	3.41	9.39	3.65	8.94	4.09	8.60	4.43	8.25	4.79	7.32	5.01	7.42	5.50
-7	9.27	3.45	9.02	3.70	8.59	4.14	8.05	4.67	7.53	5.18	6.84	5.25	7.12	5.33
-2	10.13	3.07	9.85	3.28	9.38	3.68	8.99	4.03	8.60	4.39	7.63	4.92	7.74	5.46
2	10.96	2.69	10.66	2.87	10.15	3.22	10.00	3.39	9.87	3.57	8.76	4.01	8.87	4.46
7	12.18	2.47	11.84	2.64	12.00	2.59	10.79	3.26	11.50	3.23	10.16	4.25	11.00	3.80
10	13.44	2.51	13.06	2.68	12.45	2.83	11.94	3.30	11.43	3.92	10.15	4.39	10.28	4.85
15	15.34	2.62	14.91	2.79	14.20	3.02	13.66	3.31	13.12	3.55	12.46	3.98	11.80	4.48
20	17.41	2.70	16.93	2.87	16.13	3.11	15.54	3.42	14.95	3.65	14.20	4.09	13.46	4.61
25	19.36	2.82	18.83	2.99	17.94	3.29	17.31	3.47	16.69	3.46	16.33	3.87	15.02	4.42
30	21.35	2.91	20.77	3.09	19.77	3.46	23.09	5.07	18.45	3.34	18.36	3.75	16.61	4.31
35	23.33	2.97	22.70	3.15	21.61	3.58	23.09	5.07	20.21	3.23	20.39	3.62	18.20	4.22

AE160AXED*H/EU

LWT(°C)	25		30		35		40		45		50		55	
Tamb(°C)	HC(kW)	PI(kW)	HC(kW)	PI(kW)	HC(kW)	PI(kW)	HC(kW)	PI(kW)	HC(kW)	PI(kW)	HC(kW)	PI(kW)	HC(kW)	PI(kW)
-25	10.75	5.45	10.45	5.83	9.88	6.18	9.45	6.12						
-20	12.47	5.13	12.12	5.49	11.65	5.94	11.20	6.10	10.75	6.35				
-15	13.26	5.43	12.89	5.81	12.28	6.28	11.66	6.43	11.06	6.41	9.81	6.73		
-10	12.55	4.77	12.20	5.11	11.63	5.72	11.18	6.19	10.72	6.67	9.52	6.98	9.64	7.65
-7	11.32	4.59	11.01	4.91	10.49	5.51	9.83	6.21	9.19	6.90	8.36	6.99	8.70	7.08
-2	12.49	4.08	12.15	4.37	11.57	4.90	11.08	5.37	10.60	5.84	9.41	6.54	9.54	7.26
2	13.65	3.59	13.28	3.84	12.64	4.29	12.45	4.52	12.29	4.76	10.91	5.33	11.05	5.93
7	16.24	3.62	15.79	3.86	16.00	3.76	14.37	4.67	15.30	4.54	13.49	5.96	14.60	5.32
10	17.92	3.69	17.42	3.93	16.60	4.14	15.90	4.78	15.22	5.59	13.51	6.25	13.69	6.90
15	20.45	3.87	19.89	4.12	18.94	4.46	18.21	4.83	17.48	5.14	16.60	5.74	15.72	6.46
20	23.22	3.93	22.57	4.19	21.50	4.56	20.72	5.03	19.94	5.39	18.94	6.01	17.94	6.74
25	25.82	4.02	25.11	4.29	23.92	4.75	23.09	5.07	22.26	5.11	21.78	5.73	20.03	6.57
30	28.47	4.11	27.69	4.38	26.37	4.91	23.09	5.07	24.62	4.94	24.50	5.54	22.16	6.44
35	31.11	4.20	30.27	4.46	28.82	5.07	23.09	5.07	26.98	4.77	27.22	5.36	24.28	6.32

1. Heating capacity : Capacity is according to Eurovent rating standard OM-3-2015 and valid for heated water range $\Delta t = 3\sim 8^{\circ}\text{C}$
 2. Cooling capacity : Capacity is according to Eurovent rating standard OM-3-2015 and valid for chilled water range $\Delta t = 3\sim 8^{\circ}\text{C}$
 3. Power input : Power input is according to Eurovent rating standard OM-3-2015.
 4. Peak value : Tested without defrost operation in accordance with EN14511
- ※ The real capacity would be changed according to the install environment.

2. Outdoor Units

2-8. Capacity table

2) Cooling Capacity

LWT (Leaving Water Temp.), Tamb (Ambient Temp.), CC (Cooling Capacity), PI (Power input)

AE120AXED*H/EU

LWT(°C)	7		10		13		15		18		25	
Tamb(°C)	HC(kW)	PI(kW)	HC(kW)	PI(kW)	HC(kW)	PI(kW)	HC(kW)	PI(kW)	HC(kW)	PI(kW)	HC(kW)	PI(kW)
10	11.95	1.98	12.77	1.99	13.58	2.00	14.13	2.01	14.95	2.02	16.86	2.06
20	10.77	2.44	11.59	2.45	12.40	2.46	12.95	2.47	13.77	2.48	15.68	2.52
30	9.59	2.96	10.41	2.95	11.23	2.95	11.77	3.00	12.59	3.03	14.50	3.04
35	9.00	3.10	9.52	3.32	10.32	3.44	10.84	3.44	12.00	3.10	13.49	3.76
46	7.47	4.55	8.26	4.56	9.06	4.78	9.59	4.78	10.37	4.56	12.22	4.55

AE160AXED*H/EU

LWT(°C)	7		10		13		15		18		25	
Tamb(°C)	HC(kW)	PI(kW)	HC(kW)	PI(kW)	HC(kW)	PI(kW)	HC(kW)	PI(kW)	HC(kW)	PI(kW)	HC(kW)	PI(kW)
10	14.74	2.85	15.77	2.91	16.81	2.97	17.50	3.00	18.54	3.03	20.96	3.12
20	13.32	3.33	14.36	3.39	15.39	3.45	16.09	3.49	17.12	3.54	19.54	3.63
30	11.91	3.84	12.94	3.87	13.98	3.89	14.67	3.99	15.71	4.06	18.13	4.17
35	11.20	4.00	11.87	4.29	12.87	4.49	13.53	4.50	15.00	4.14	16.89	5.07
46	9.35	5.70	10.35	5.73	11.37	6.06	12.03	6.10	13.03	5.86	15.37	5.95

1. Heating capacity is according to Eurovent rating standard OM-3-2015 and valid for heated water range $\Delta t = 3\text{--}8^{\circ}\text{C}$
2. Cooling capacity is according to Eurovent rating standard OM-3-2015 and valid for chilled water range $\Delta t = 3\text{--}8^{\circ}\text{C}$
3. Power input is total of indoor and outdoor unit, according to Eurovent rating standard OM-3-2015.

※ The real capacity would be changed according to the install environment.

2. Outdoor Units

2-9. Capacity correction

1) Heating

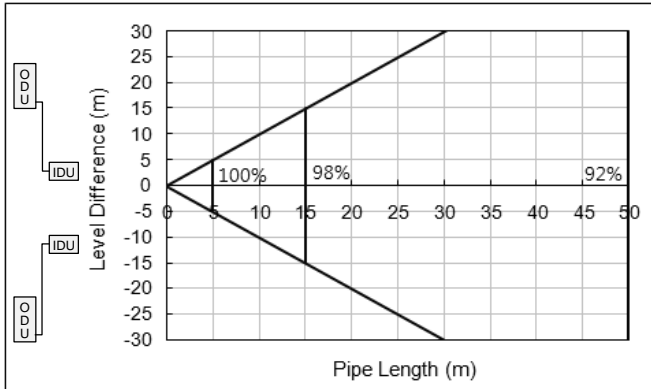

2) Cooling

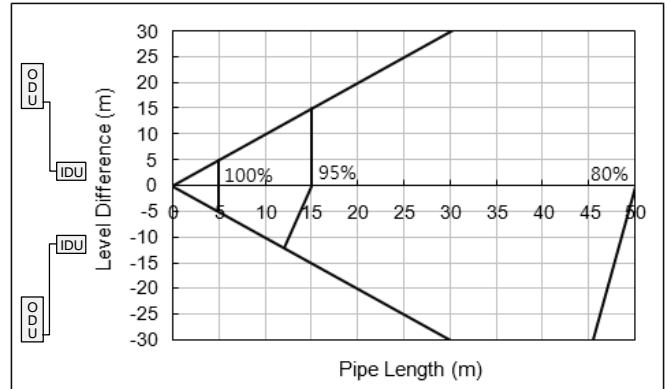

3. Hydro Unit

3-1. Specifications

Model Name	Indoor Unit			AE160ANYDEH/EU	AE160ANYDGH/EU	
Hydro Unit	Power Supply			V, Hz, Φ	220~240, 50, 1	380~415, 50, 3
	Field Wiring	Hydro Unit	MAX INPUT	kW	6.20	6.20
			MCA	A	27.9	9.3
			MFA	A	34.9	11.6
	Water Pump	Type (Model Name)		-	Centrifurugal (Stratos 25 1-9)	Centrifurugal (Stratos 25 1-9)
		Rated Current		A	0.9	0.9
		Motor Input		W	90	90
		Number of Unit		EA	1	1
	Flow SENSOR	Type (Model Name)		-	FLOW SENSOR	FLOW SENSOR
		Min. flow rates		LPM	12	12
	Electric Heater			W	6,000	6,000
	Expansion Vessel			Liter	8	8
	Pressure Relief Valve			bar	2.9	2.9
	Air Purge Valve			Φ , inch	BSPP male 3/8	BSPP male 3/8
	Service Valve			Φ , inch	BSPP male 1 1/4	BSPP male 1 1/4
	Sound *1	Sound Pressure	Heating	dB(A)	30	30
		Sound Power	Heating	dB(A)	44	44
	External Dimension	Net Weight		kg	45.0	46.5
		Shipping Weight		kg	55.0	56.0
		Net Dimensions (WxHxD)		mm	510 x 850 x 315	510 x 850 x 315
		Shipping Dimensions (WxHxD)		mm	564 x 1,024 x 426	564 x 1,024 x 426
	External Control	Back up Boiler		-	AC 230V (Max 10mA)	AC 230V (Max 10mA)
		Room Thermostat		-	AC 230V (Max 22mA)	AC 230V (Max 22mA)
		Solar Pump		-	AC 230V (Max 10mA)	AC 230V (Max 10mA)
Valves, 2 or 3way		-	AC 230V (Max 22mA)	AC 230V (Max 22mA)		

*1) Sound level was acquired in an anechoic room. Thus actual noise level may be different depending on the installation conditions.

3. Hydro Unit

3-2. Dimensional drawing

Unit : mm

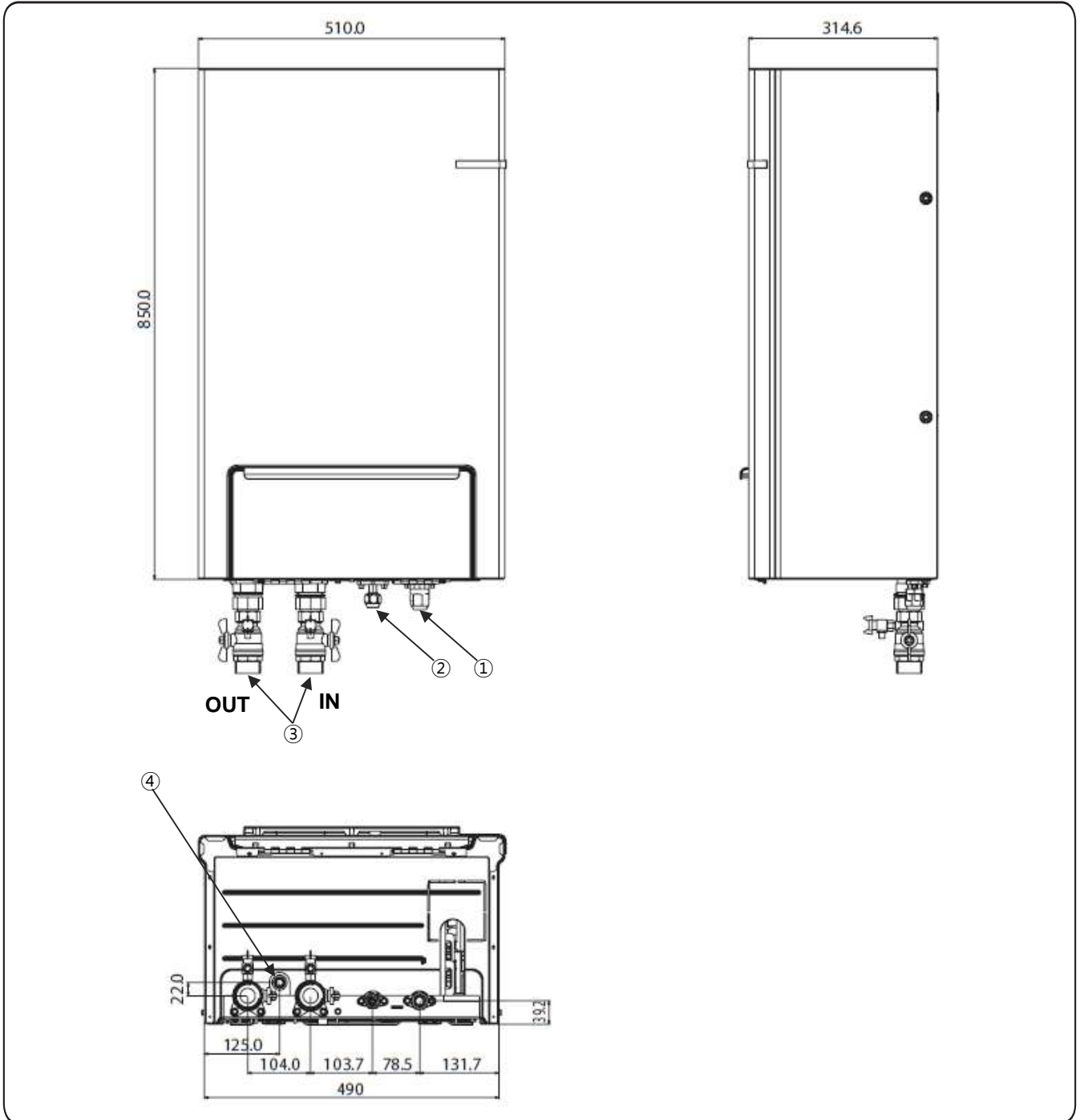

NO	Name	Description
1	Refrigerant Gas pipe	Ø15.88
2	Refrigerant liquid pipe	Ø9.52
3	Water Pipe (Outlet/Inlet)	-
4	Drain Holes	-

3. Hydro Unit

3-3. Electrical wiring diagram

AE160ANYDGH/EU

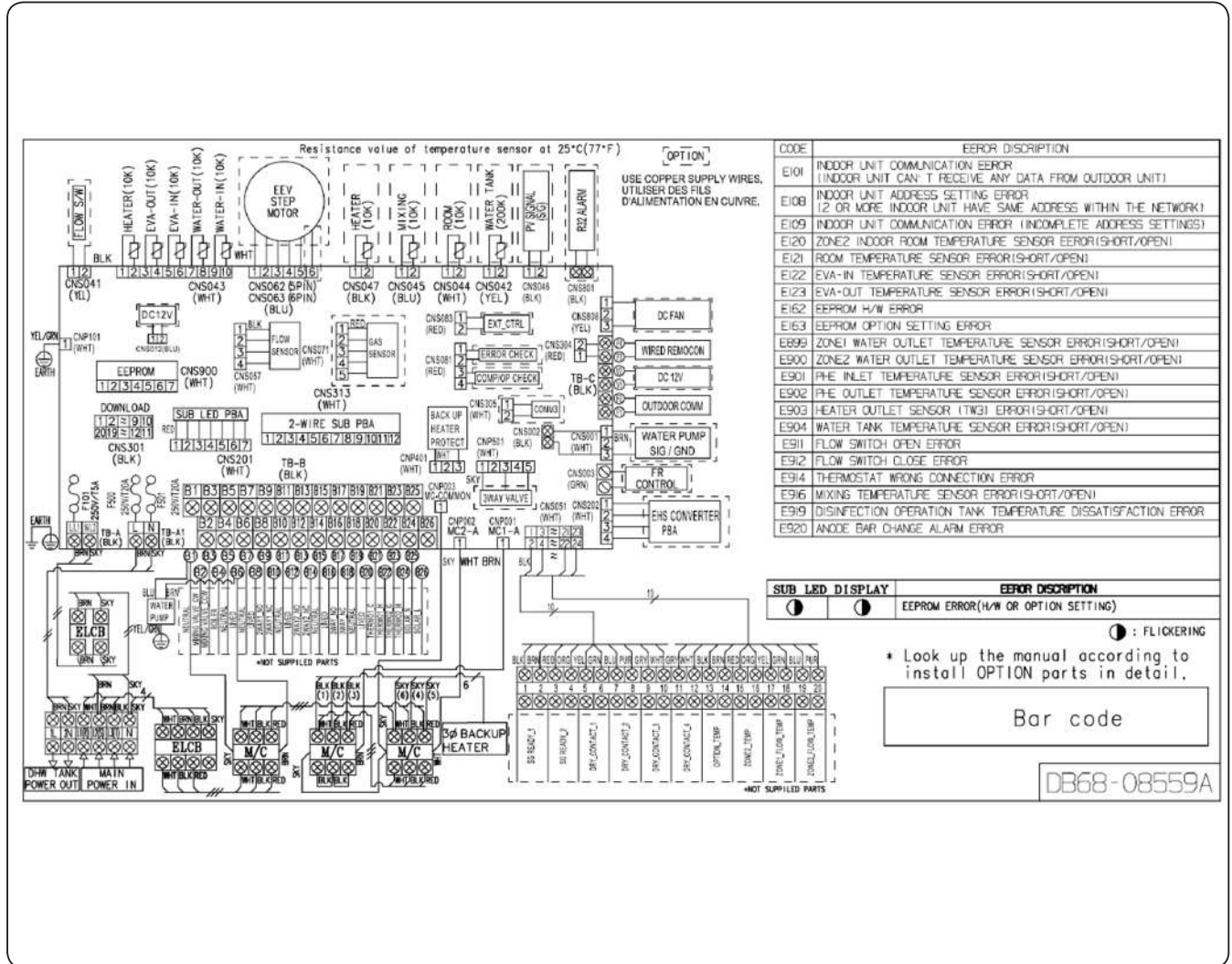

HEATER	Thermistor HEATER	EVA-OUT	Thermistor EVA-OUT
EVA-IN	Thermistor EVA-IN(10K)	WATER-OUT	Thermistor WATER-OUT(10K)
WATER-IN	Thermistor WATER-IN(10K)	WATER TANK	Thermistor WATER TANK(200K)
MIXING	Thermistor MIXING VALVE(10K)	ROOM	Thermistor - Indoor Room
SIG/GND	Signal/Ground	ELCB	Earth Leakage Circuit Breaker
M/C	Magnetic Contactor	WIRED REMOCON	Wired Remote Controller
EUV STEP MOTOR	Electronic expansion valve STEP MOTOR		

NOTE

1. This wiring diagram applies only to the Indoor unit.
2. Symbols show as follow :
blk: black, red: red, blu: blue, wht: white, yel: yellow, brn: brown, sky: skyblue, grn: green
3. For connection wiring indoor-outdoor transmission F1-F2, indoor-wired remote controller transmission F3-F4.
4. ⚡ Protective earth(SCREW)

3. Hydro Unit

3-4. Sound data

Sound Pressure level

Unit: dB(A)

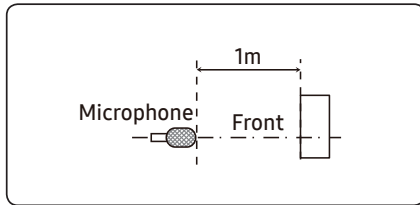

Model	Heating
AE160ANYDEH/EU	30
AE160ANYDGH/EU	30

- NR Curve

1) AE160ANYDEH/EU

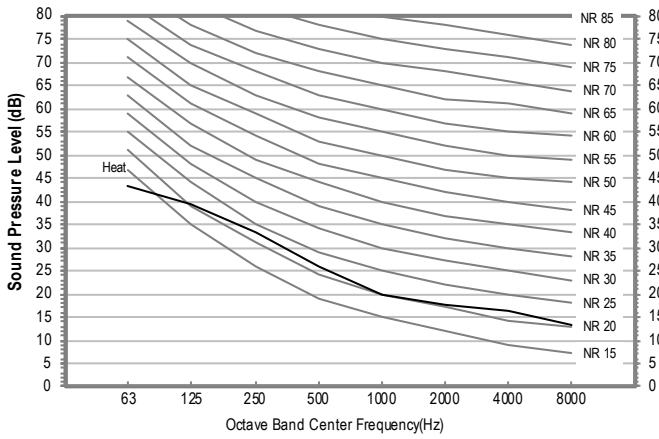

2) AE160ANYDGH/EU

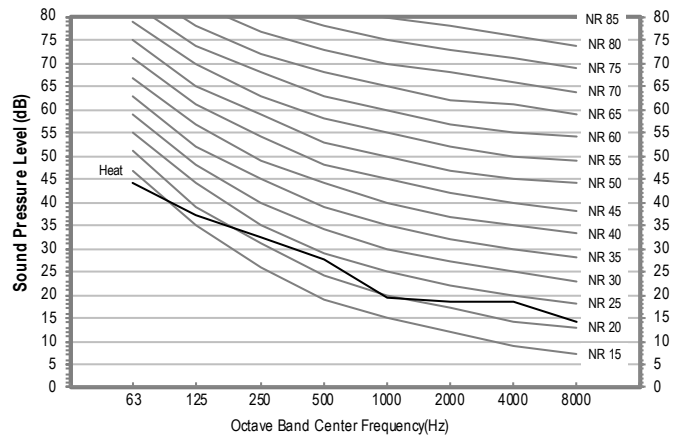

NOTE

- Specifications may be subject to change without prior notice.
- Sound Pressure Level
 - Sound pressure level is obtained in an anechoic room.
 - Sound pressure level is a relative value, depending on the distance and acoustic environment.
 - Sound pressure level may differ depending on operation condition.
 - dBA = A weighted sound pressure level
 - Reference acoustic pressure 0 dB = 20μPa

3. Hydro Unit

3-4. Sound data

Sound Power level

NOTE

- Specifications may be subject to change without prior notice
 - Sound power level is an absolute value that a sound source generates.
 - dBA = A-weighted sound power level.
 - Reference power : 1pW.
 - Measured according to ISO 3741.

Model	Power (dBA)
AE160ANYDEH/EU	44
AE160ANYDGH/EU	44

1) AE160ANYDEH/EU

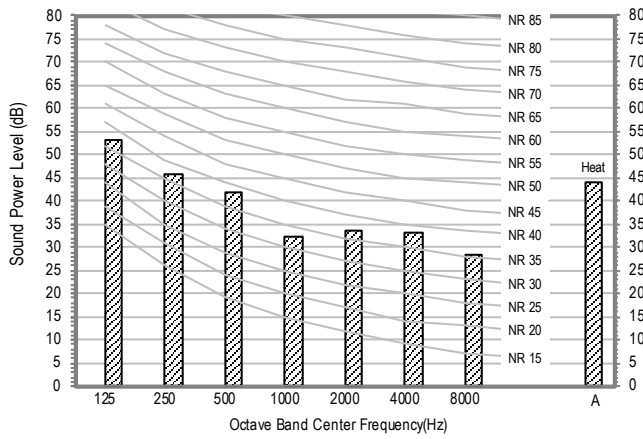

2) AE160ANYDGH/EU

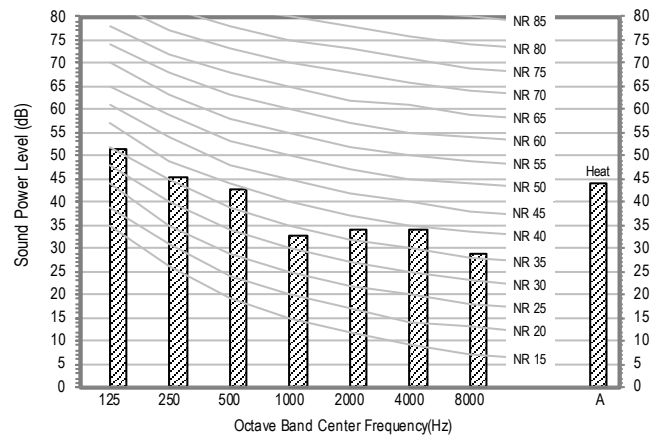

3. Hydro Unit

3-5. Piping diagram

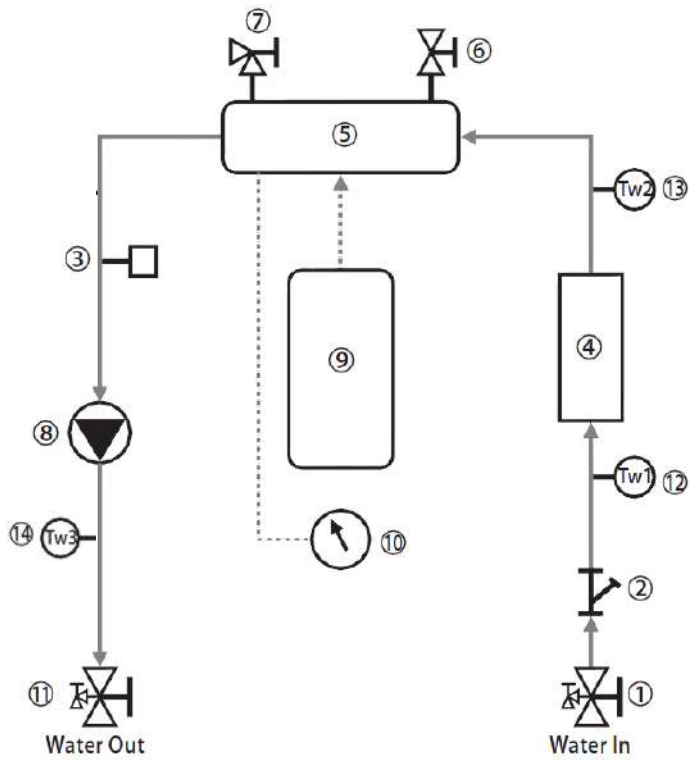

No.	Description
①	Water Pipe Service Valve (R)
②	Strainer
③	Flow Sensor
④	Heat Changer
⑤	Backup Heater
⑥	Pressure Relief Valve
⑦	Air-vent
⑧	Variable Speed water pump
⑨	Expansion Tank
⑩	Manometer

No.	Description
⑪	Water Pipe Service Valve (L)
⑫	Water Temp. Sensor 1
⑬	Water Temp. Sensor 2
⑭	Water Temp. Sensor 3

4. Installation

Hydro unit

Application 1: Space heating

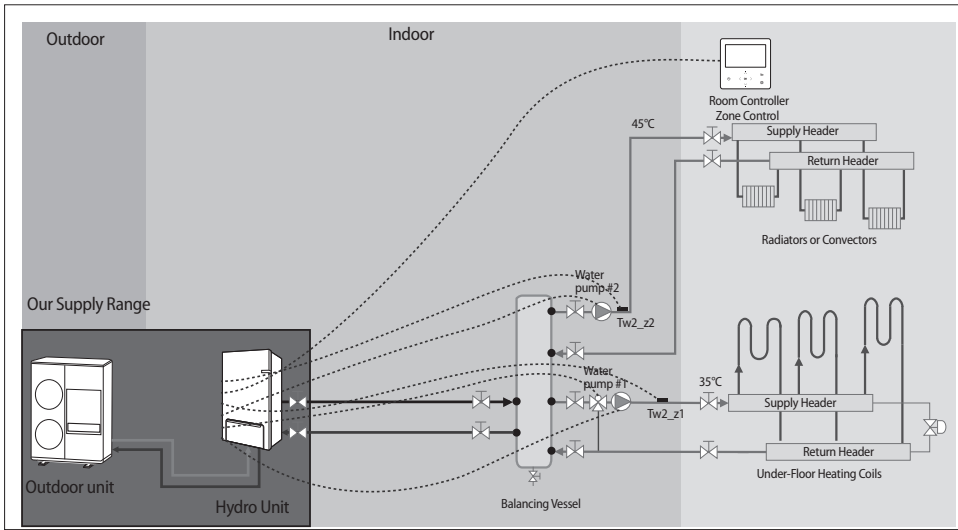

Application 2: Space heating + water heating

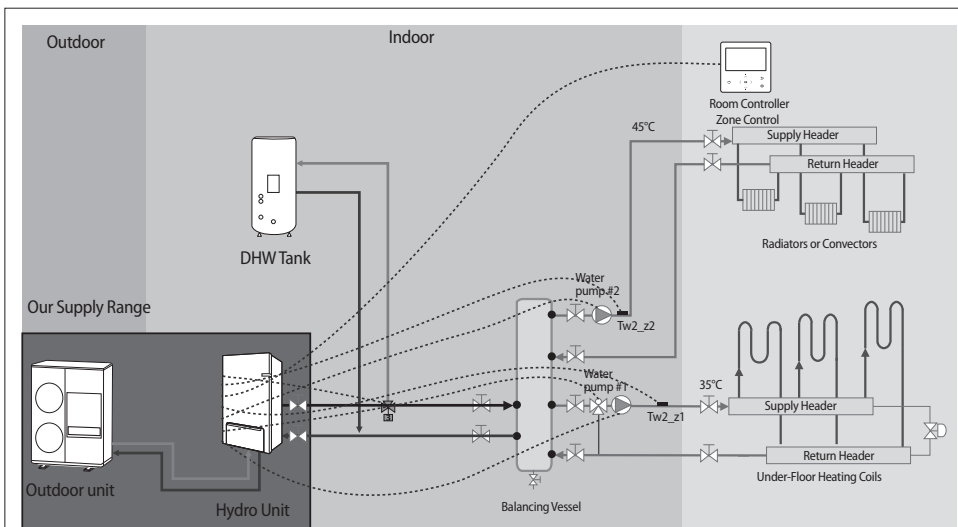

Application 3: Hybrid application (backup boiler and solar panel connected)

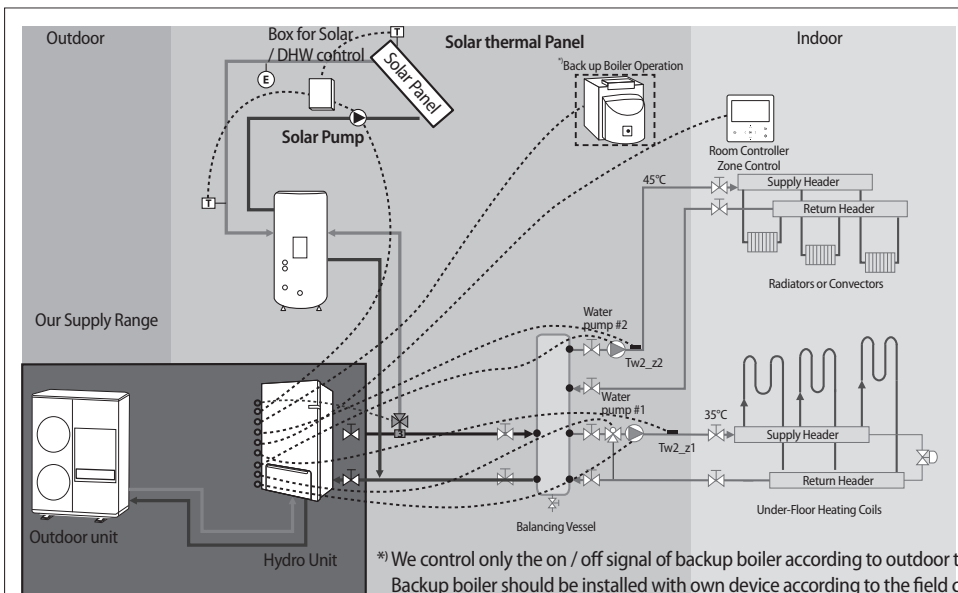

* We control only the on / off signal of backup boiler according to outdoor temperature. Backup boiler should be installed with own device according to the field condition.

4. Installation

Hydro unit

Installation of the indoor unit

The indoor unit should be installed indoors and meet the following conditions.

- ← Installation site should be sheltered from frost.
- ← In area with suitable space for servicing.
- ← A place with adequate ventilation.
- ← Where there is no risk of leakage of flammable gases.
- ← There is a provision for condensate drain and pressure relief valve blow-off.
- ← The wall for installation is a flat, vertical and non-combustible wall, capable of supporting the operation weight of the unit.

Installation space

- ← Ensure to leave the appropriate space as indicated in the drawing.
- ← Installation site should be secured with adequate ventilation so that the components of hydro unit will not be damaged from overheating.

(Unit : mm)

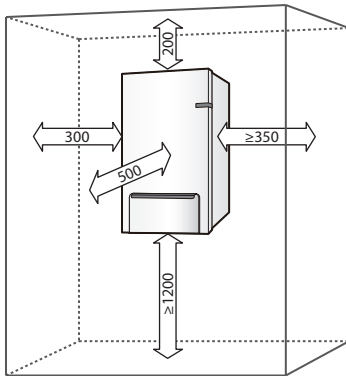

- ← Before installing the indoor unit, fix the pattern sheet on the wall. This sheet has a function to take correct position for the wall mounting bracket and screws.

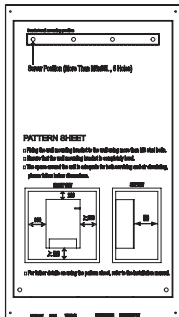

Pattern Sheet

Refrigerant pipe work

For all guide lines, specifications regarding refrigerant pipe work between the indoor unit and the outdoor unit, please follow the outdoor unit installation manual.

	Gas pipe (O.D.)	Liquid pipe (O.D.)	Tightening Torque	Final Torque
Indoor unit	15.88 mm (5/8 inch)	9.52 mm (3/8 inch)	400 kg-cm	450 kg-cm
Outdoor unit	15.88 mm (5/8 inch)	9.52 mm (3/8 inch)	700 kg-cm	750 kg-cm

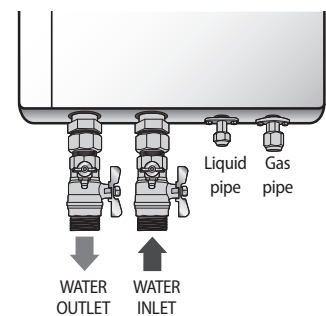
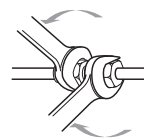

- When connecting the refrigerant pipes, always use 2 wrenches/spanners for tightening or loosening nuts. If not, piping connections can be damaged.

4. Installation

Hydro unit

Water pipe work

The hydro unit is equipped with components listed on the table below.

The hot and cold water supply connections are clearly marked on the unit with labels. And service valves are provided. Whole water plumbing system including Hydro unit shall be installed by a qualified technician and must comply with all relevant European and national regulations.

← Allowable water pressure of hydro unit is maximum 3.0bar.

← 2 service valves are provided with the Hydro unit. To facilitate service and maintenance work, install R-Type service valve at the water inlet of the hydro unit and L-Type service valve at the water outlet of the hydro unit.

← An air-vent valve is integrated on the hydro unit. Please check that air-vent valve is not overtightened so the air-vent valve can release any air out of the system during system operation.

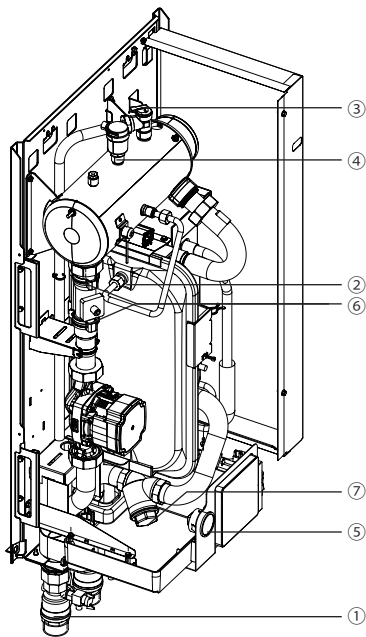

	No.	Name	Tightening Torque	
Hydro unit	①	1.25" BSPP	350 ~ 380 kgf-cm	34 ~ 37 N·m
	②	3/8" BSPP	120 ~ 150 kgf-cm	12 ~ 15 N·m
	③	Pressure relief valve	120 ~ 150 kgf-cm	12 ~ 15 N·m
	④	Air-vent valve	120 ~ 150 kgf-cm	12 ~ 15 N·m
	⑤	Manometer	92~ 102 kgf-cm	9 ~ 10 N·m
	⑥	Flow Sensor	O-ring type	O-ring type
	⑦	Strainer	350 ~ 380 kgf-cm	34 ~ 37 N·m

ESP(External Static Pressure) Diagram

The illustration below shows the external static pressure of the unit depending on the water flow and the pump setting.

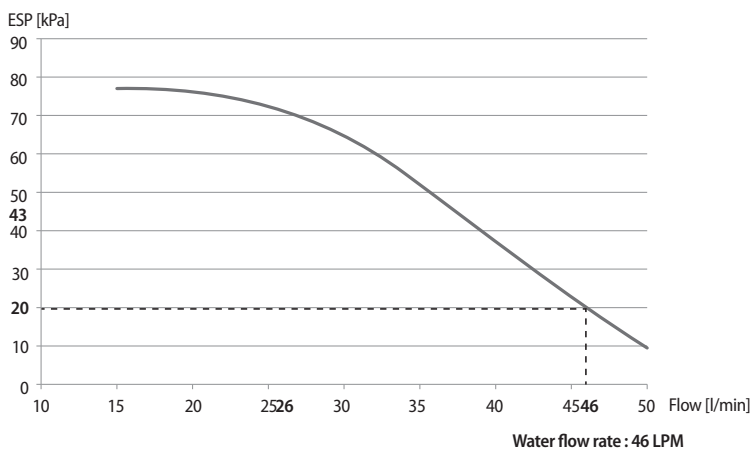

If the pressure loss of total system is over 20kPa, additional water pump should be installed in series.

Otherwise, the flow rate might decreased, causing insufficient heating or cooling.

When ESP is not enough, additional pump should be installed. In this case, install the PWM control external type pump (Heating type) additionally.

4. Installation

Hydro unit

Connection guide of additional pump

Case 1) INV. pump

Connect the PWM control external type pump to PWM terminal block and power cable to the external contact terminal.

The maximum number of additional pump installation is one inverter pumps (Input power 100W).

1. Power supply (For additional INV. Pump)

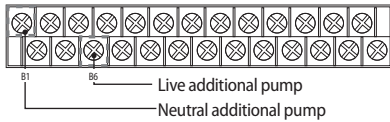

2. PWM control (For additional INV. Pump only), refer to page 24, 25

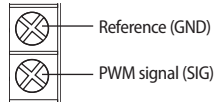

• If there is wrong wiring between PWM and reference, INV. Water Pump may not work or wrong operation.

PWM characteristic curve

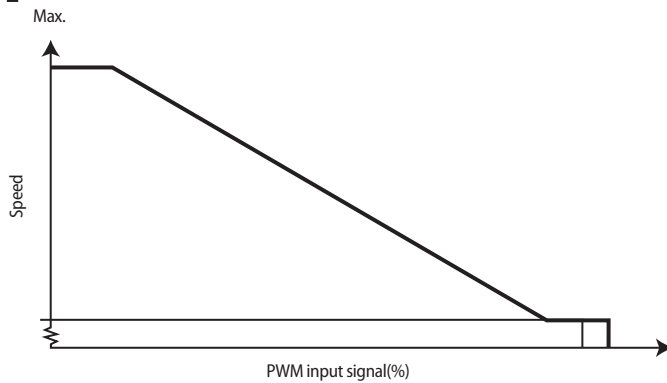

The additional pump should be the same type of product as the above graph.

Recommendation

WILO STRATOS PARA 25/1-9 (Heating Type)

Case 2) AC pump

Only a single additional AC pump is allowed.

1. Power supply (AC Pump)

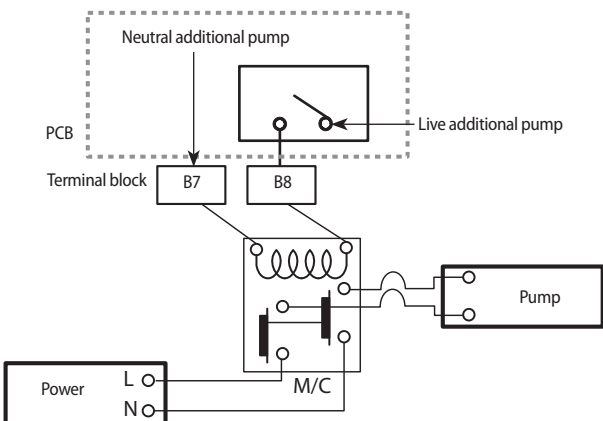
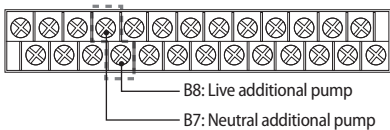

• The maximum allowable current that this terminal block can supply for the additional water pump is 0.1 A.

4. Installation

Hydro unit

Setting the pre-pressure of the expansion vessel

When it is required to change the default pre-pressure of the expansion vessel(1 bar), keep in mind the following guidelines:

- ▶ Use only dry nitrogen to set the expansion vessel pre-pressure.
- ▶ Inappropriate setting of the expansion vessel pre-pressure will lead to malfunction of the system. Therefore, the pre-pressure should only be adjusted by a licensed installer.

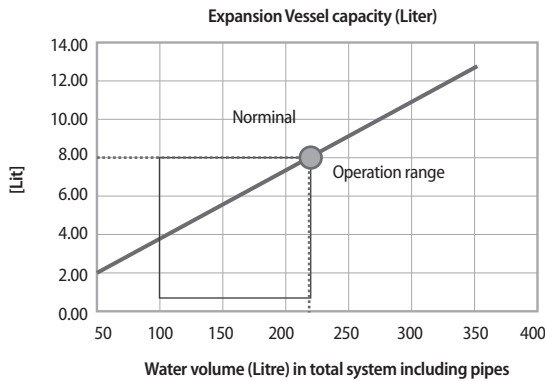

- Water volume of total system for reliable performance is minimum 50 liters.

Installation height difference ^{a)}	Water volume	
	< 220 Litres	> 220 Litres
< 7 m	No pre-pressure adjustment required.	Actions required: <ul style="list-style-type: none"> • Pre-pressure must be decreased, calculate according to "Calculating the pre-pressure of the expansion vessel". • Check if the water volume is lower than maximum allowed water volume
> 7 m	Actions required: <ul style="list-style-type: none"> • Pre-pressure must be increased, calculate the appropriate value following by "Calculating the pre-pressure of the expansion vessel". • Check if the water volume is lower than maximum allowed water volume 	Expansion vessel of the unit too small for the installation.

a) Installation height difference: height difference(m) between the highest point of the water circuit and the indoor unit. If the indoor unit is located at the highest point of the installation, the installation height is considered 0 m.

Calculating the pre-pressure of the expansion vessel

The pre-pressure(P_g) to be set depends on the maximum installation height difference(H) and is calculated as below:

$$P_g = (H/10 + 0.3) \text{ bar}$$

4. Installation

Hydro unit

Torque requirements

C-BOX: SINGLE PHASE

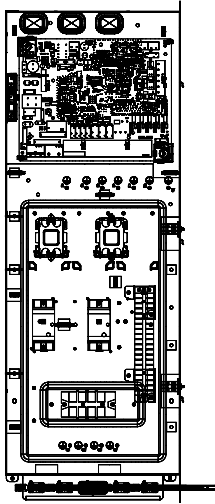

C-BOX: 3 PHASE

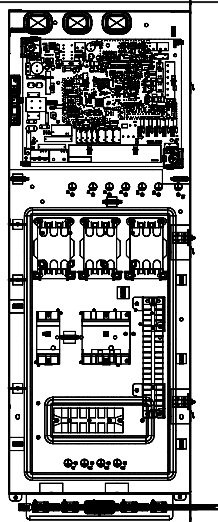

Screw size	Tightening torque (N·m)	Part	Terminal code	Remarks
M3	0.5~0.75	20P Terminal Block	1~20	Digital input/output
M5	2.0~2.9	Magnetic contactor 2P Single phase	-	AC 220V-240V power input/output
		Magnetic contactor 3P 3phase	-	AC 380V-415V power input/output
		ELCB 2P Single phase	-	AC 220V-240V power input/output
		ELCB 4P 3 phase	-	AC 380V-415V power input/output
		Terminal block 4P Single phase	1(L), 2(N)	AC220-240V Power output
			L, N	AC220-240V Power input
Terminal block 6P 3 phase	1(L), 2(N)	AC220-240V Power output		
	L1(R), L2(S), L3(T), N	AC 380V-415V power input		

Grounding work

- ▶ Grounding must be done by a qualified installer for your safety.

Grounding the power cable

- ▶ The standard of grounding may vary according to the rated voltage and installation place of a heat pump.
- ▶ Ground the power cable according to the following.

Power condition	Installation place		
	High humidity	Average humidity	Low humidity
Electrical potential of lower than 150V		Perform the grounding work 3. ^{Note 1)}	Perform the grounding work 3 if possible for your safety. ^{Note 1)}
Electrical potential of higher than 150V	Must perform the grounding work 3. ^{Note 1)} (In case of installing circuit breaker)		

* Note 1) Grounding work 3

- Grounding must be done by your installation specialist.
- Check if the grounding resistance is lower than 100 Ω.

When installing a circuit breaker that can cut the electric circuit in case of a short circuit, the allowable grounding resistance can be 30~500 Ω.

4. Installation

Hydro unit

Checking correct grounding

If the power distribution circuit does not have a grounding or the grounding does not comply with specifications, an grounding electrode must be installed. The corresponding accessories are not supplied with the Air to Water Heat pump.

1. Select an grounding electrode that complies with the specifications given in the illustration.

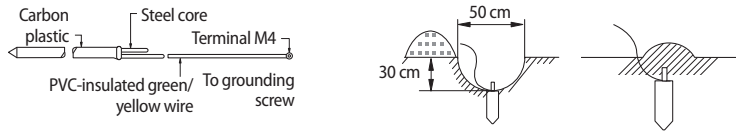

2. Connect the flexible hose to the flexible hose port.
 - ▶ In damp hard soil rather than loose sandy or gravel soil that has a higher grounding resistance.
 - ▶ Away from underground structures or facilities, such as gas pipes, water pipes, telephone lines and underground cables.
 - ▶ At least two metres away from a lightning conductor grounding electrode and its cable.



NOTE

- The grounding wire for the telephone line cannot be used to ground the Air to Water Heat pump.

3. Finish wrapping insulating tape around the rest of the pipes leading to the outdoor unit.
4. Install a green/yellow coloured grounding wire:
 - ▶ If the grounding wire is too short, connect an extension lead, in a mechanical way and wrapping it with insulating tape (do not bury the connection).
 - ▶ Secure the grounding wire in position with staples.



NOTE

- If the grounding electrode is installed in an area of heavy traffic, its wire must be connected securely.

5. Carefully check the installation, by measuring the grounding resistance with a ground resistance tester. If the resistance is above required level, drive the electrode deeper into the ground or increase the number of grounding electrodes.
6. Connect the grounding wire to the electrical component box inside of the outdoor unit.

Connection of the power supply and communication cable

Model	Description	No. of wires	Max. A	Thickness	Supply Scope
AE160ANYDEH	1 Phase main power	2 + ground	27.9 A	4.0mm ² ↑ H05RN-F or H07RN-F	Field supply (220-240Vac, Input)
	Communication	2	0.1 A	0.75mm ² ↑ H05RN-F or H07RN-F	Field wiring (7Vdc, data)
AE160ANYDGH	3 Phase power	4 + ground	9.3 A	2.5mm ² ↑ H07RN-F	Field supply (380-415Vac, Input)
	Communication	2	0.1 A	0.75mm ² ↑ H05RN-F or H07RN-F	Field wiring (7Vdc, data)

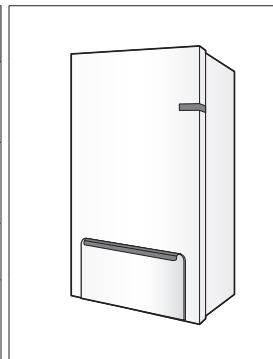

*When you use inlet hole through the cabinet top positions for power/communication wires, please fix the wire by using mount tie of the cabinet right.

2 wires for communication cable

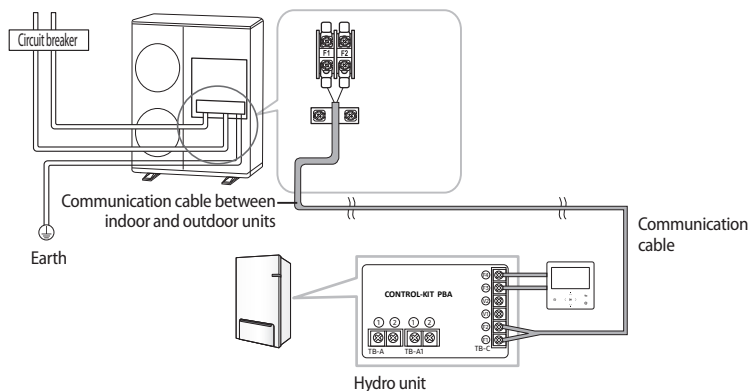

4. Installation

Hydro unit

Communication cable connection

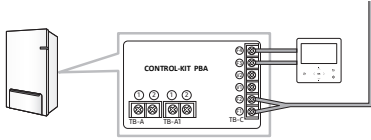

1. 1 phase product

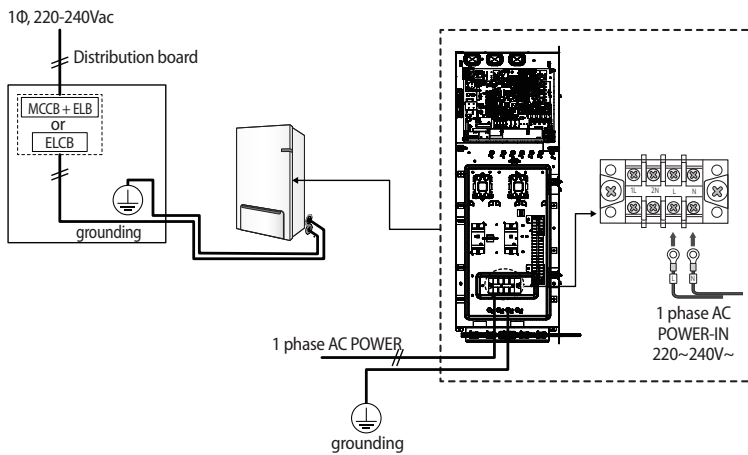

2. 3 phase product

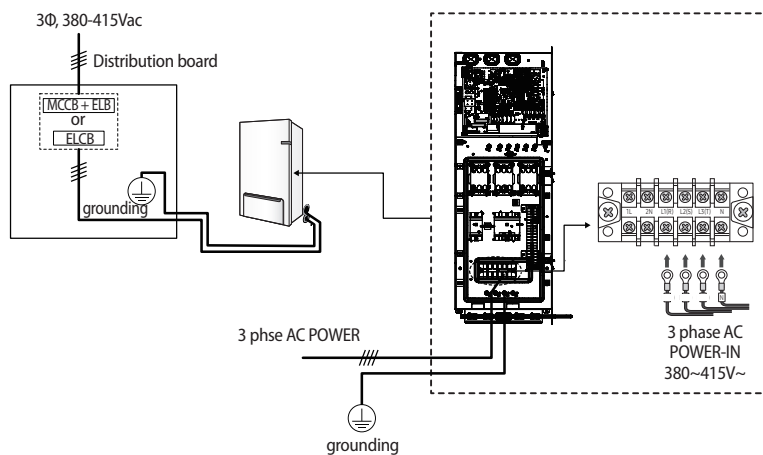

CAUTION

- If the supply cable is damaged, it must be replaced by a special cable or assembly available from the manufacturer or installer.
- Circuit Breaker (ELCB, ELB, MCCB etc.) for outdoor and indoor units shall be installed by installers because they are not sub-parts in the units. But you don't need to install for hydro unit (Built-in ELCB).
- It cause damage to chassis, PCB parts if the main power is not connected correctly. You should make certain that R, S, T is connected correctly before turning on the main power. (3 phase models only)

- * ELCB : Earth leakage circuit breaker
- ELB : Earth leakage breaker
- MCCB : Molded case circuit breaker

4. Installation

Hydro unit

Connecting the power terminal

- ▶ Connect the cables to the terminal board using the solderless terminal.
- ▶ Use certified and reliable cables.
- ▶ Connect the cables with the torque chart as below.
- ▶ If the terminal is loose, fire may occur caused by arc. If the terminal is connected too firmly, the terminal may be damaged.
- ▶ External force should not be applied to the terminal block and wires.
- ▶ The cable ties to fasten the wire should be an incombustible material, V0 or above. (The cable ties should be used to fasten the power wire and they are supplied with the unit.)

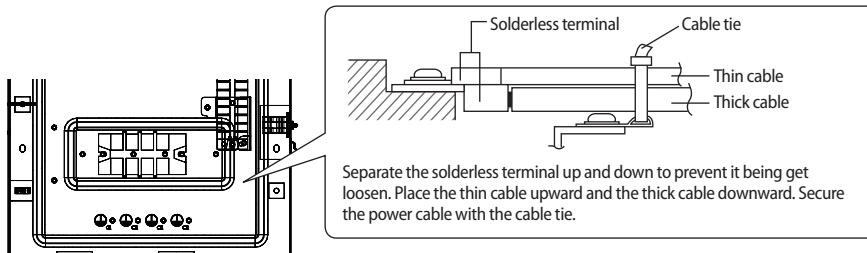

Tightening Torque (kgf · cm)	
M3	5~7.5
M5	20 ~ 30

Connection of the backup heater power supply



- Do not use a power supply shared by other appliances. Each components for outdoor unit, indoor unit, backup heater and booster heater has the dedicated power supply.

Model	Heater capacity (kW)	ELCB capacity (A)
AE160ANYDEH	6	40
AE160ANYDGH	6	20

* Circuit Breaker(ELCB, ELB, MCCB etc.)s written above are already included in the hydro unit.

ELCB : Earth leakage circuit breaker

ELB : Earth leakage breaker

MCCB : Molded case circuit breaker

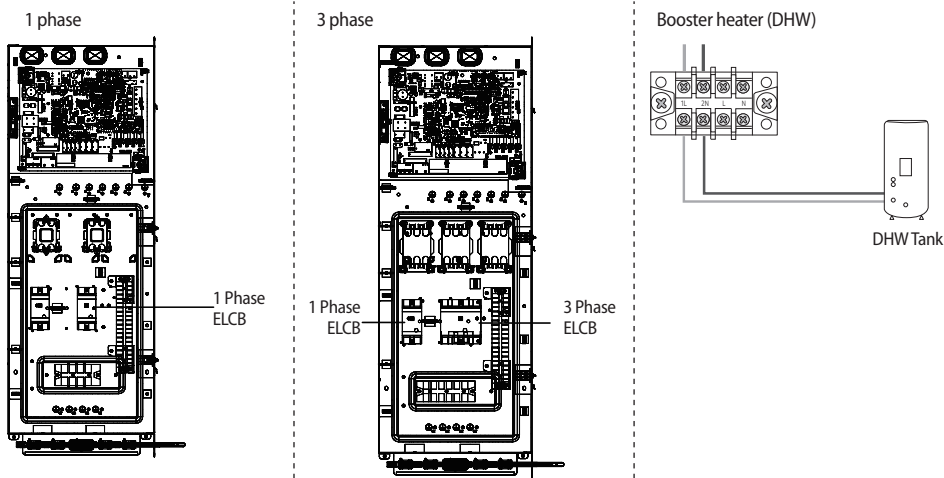

4. Installation

Hydro unit

Connection of the thermostat

Description	No. of wires	Max. current	Thickness	Supply Scope
Room Thermostat	4	22mA	> 0.75 mm ² , H05RN-F or H07RH-F	Field supply (220-240V~, Input)

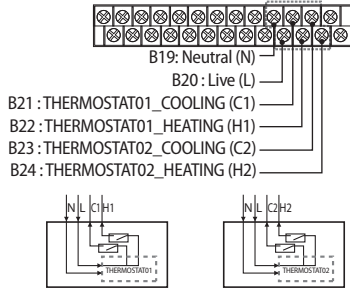

1. Before the installation, hydro unit should be turned off.
2. Using the appropriate equipment to correct position of terminal block as shown on the diagram.
3. Determine the thermostat type.
 - Normal OPEN or Normal CLOSED.
 - Contact signal must be "L". When installing two thermostats, thermostat2 is prior to thermostat1.

CAUTION • Product will not operate when signal for cooling and heating mode is inputted at the same time.

Connection of the 2-way valve

Description	No. of wires	Min. / Max. current	Thickness	Supply Scope
Motorized 2-way valve to shut off UFH loops during cooling.	2+ground	10mA / 50mA	> 0.75 mm ² , H05RN-F or H07RH-F	Field supply (220-240V~, Output)

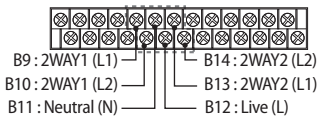

* Connection of 2 wires 2-way valve

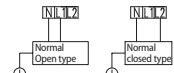

In case of normal open type

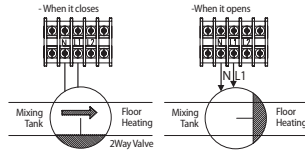

In case of normal closed type

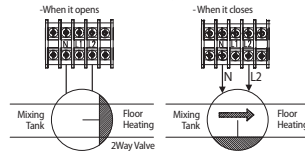

- 2-way motorized valve
- ▶ When outlet water temperature reach to lower than 16 °C in cooling mode, UFH loops will be closed.
 - ▶ 220-240V~
 - ▶ 2 wires(Normal Open or Normal Close)
1. Before the installation, hydro unit should be turned off.
 2. Using the appropriate equipment to correct position of terminal block as shown on the diagram.
 3. Determine the motorized valve type.

- Normal OPEN or Normal CLOSED.

CAUTION • There are 2 types of 2-way valve, normal open type and normal closed type. Make sure to connect terminals to right positions of terminal block. As detailed on the wiring diagram and illustrations above.

Connection of the water pump for 2-zone control (FSV 4061=1)

- ▶ Zone1 water pump connection: B10(L1) + B11(N)
- ▶ Zone2 water pump connection: B14(L1) + B15(N)

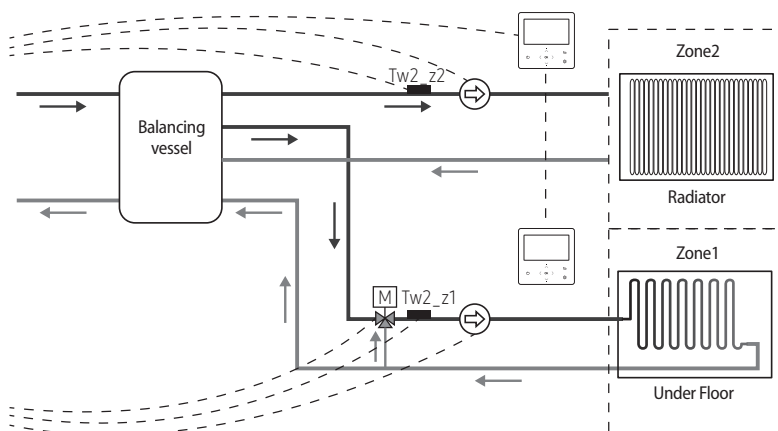

CAUTION • There are 2 types of 2-way valve, normal open type and normal closed type. Make sure to connect terminals to right positions of terminal block. As detailed on the wiring diagram and illustrations above.

• To use the zone control (FSV #4016=1), set the thermostat control option (FSV #2091 & #2092) to "0" for disabling it.

4. Installation

Hydro unit

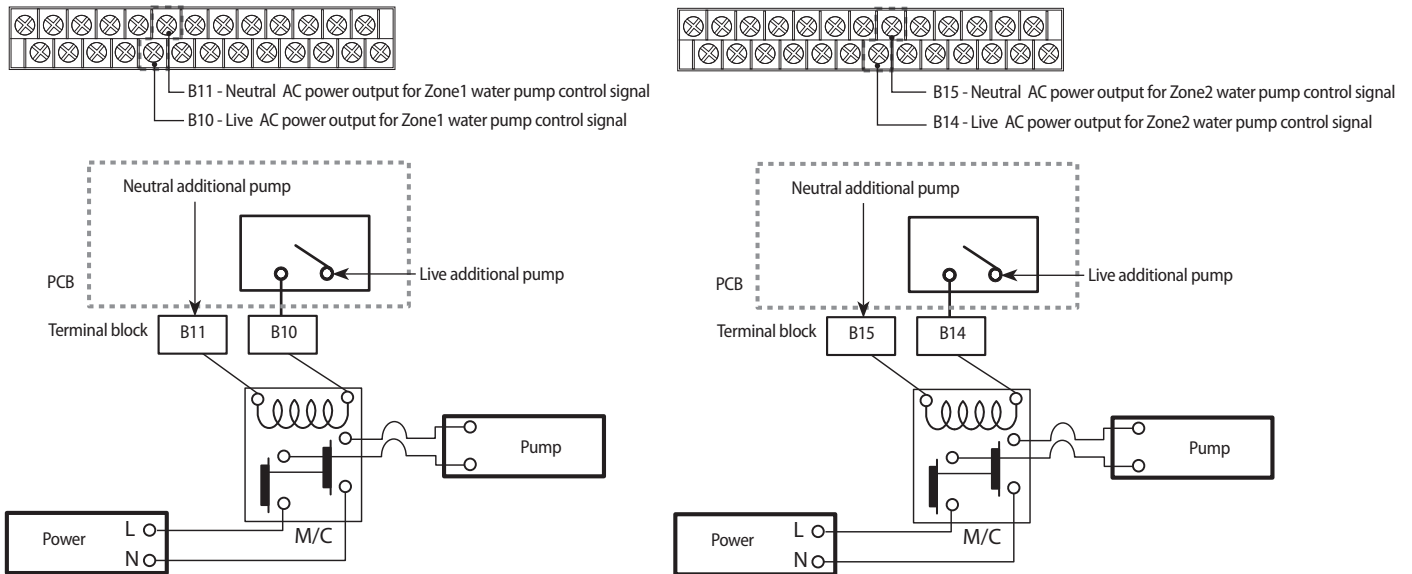

CAUTION • The maximum allowable current that this terminal block can supply for the additional water pump is 50mA.

Connection of the 3-way valve

Description	No. of wires	Mini. / Max. current	Thickness	Supply Scope
Diverting type 3way valve	4	10mA / 50mA	> 0.75 mm ² , H05RN-F or H07RN-F	Field supply (220-240V~, Input)

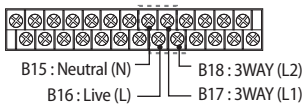

Status	L1	L2
A (Initial)	OFF	ON
B	ON	OFF

3-way diverting valve for water tank

- ▶ When cooling operating mode, floor heating loops will be closed.
- ▶ 220-240V~

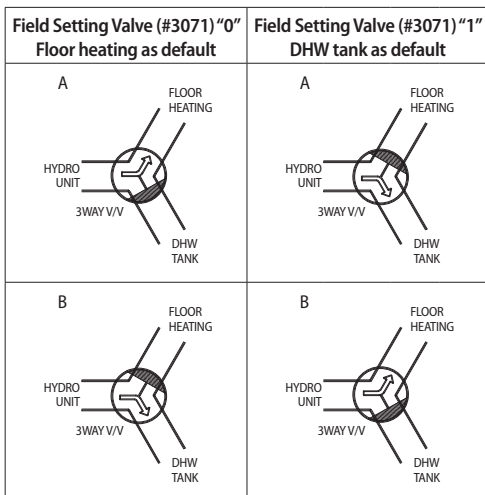

1. Before the installation, hydro unit should be turned off.
2. Using the appropriate equipment to correct position of terminal block as shown on the diagram.
3. Make sure what type of 3 way V/V you use.

4. Installation

Hydro unit

Connection of the back-up boiler

Description	No. of wires	Mini. / Max. current	Thickness	Supply Scope
Back-up Boiler	2+ground	10mA / 50mA	0.75mm ² H05RN-F or H07RN-F	Field supply (220-240V~, Input)

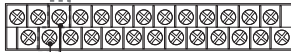

B5 : Neutral (N)
B4 : Back-up boiler (L)

When it set back up boiler on the hydro unit (relay off)

When it order to back up boiler operates (relay on)

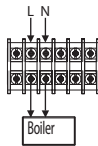
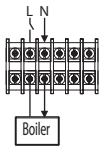

1. Before the installation, hydro unit should be turned off.
 2. Using the appropriate equipment to correct position of terminal block as shown on the diagram.
 3. Make sure EXT-CTRL signal of back up boiler must be 230Vac.
 - Do not connect supply power of back up boiler directly.
- * Heat pump does not work when the Back-up boiler operates.

Connecting for external contact functions

Screw size	Tightening torque (N·m)	Part	Terminal code
M3	0.5~0.75	20P Terminal block	1~20

Connecting external sensors for zone control

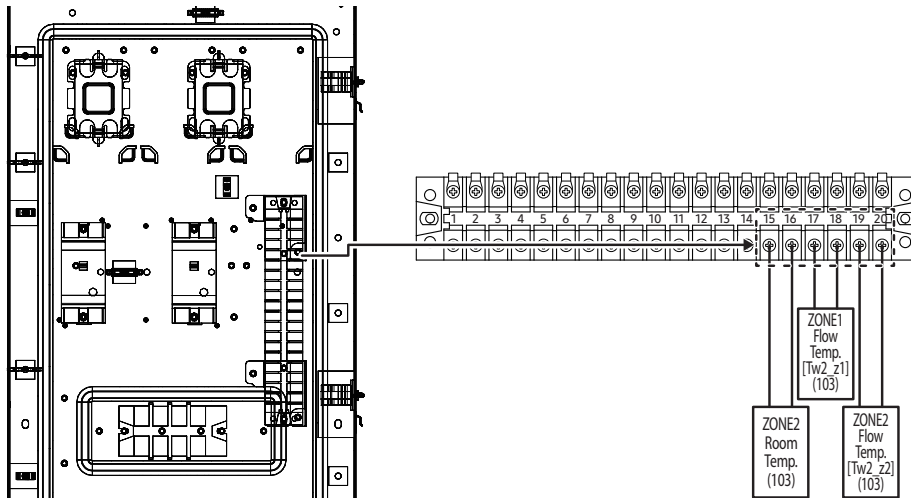

- When connecting sensors, use a Thermistor with the specifications of 10 kΩ at 25 °C, B constant = 3435 k.

4. Installation

Hydro unit

Connecting for smart grid ready control

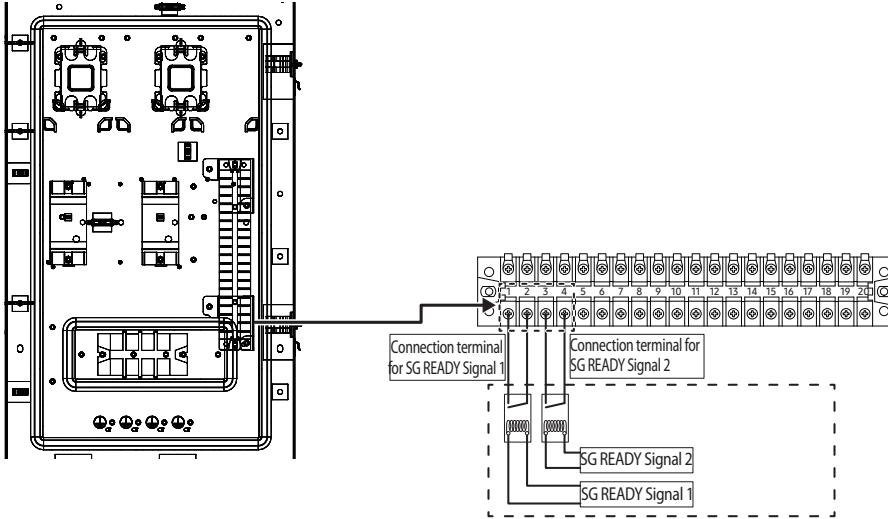

SG READY Signal 1	SG READY Signal 2	Product operation
Short	Open	Forced thermo off operation
Open	Open	Normal operation
Open	Short	Heating / DHW setting temperature 1step-up operation
Short	Short	Heating / DHW setting temperature 2step-up operation



CAUTION

- These parts are optional and not included with the product.
- Maker sure to connect to non-power on/off contacts.

4. Installation

Outdoor unit

Deciding on where to install the outdoor unit

Decide the installation location regarding the following condition and obtain the user's approval.

- ▶ The outdoor unit must not be placed on its side or upside down, as the compressor lubrication oil will run into the cooling circuit and seriously damage the unit.
- ▶ Choose a location that is dry and sunny, but not exposed to direct sunlight or strong winds.
- ▶ Do not block any passageways or thoroughfares.
- ▶ Choose a location where the noise of the Air to Water Heat Pump when running and the discharged air do not disturb any neighbours.
- ▶ Choose a position that enables the pipes and cables to be easily connected to the other hydraulic system.
- ▶ Install the outdoor unit on a flat, stable surface that can support its weight and does not generate any unnecessary noise and vibration.
- ▶ Position the outdoor unit so that the air flow directly stream towards the open area.
- ▶ Place the outdoor unit where there are no plants and animals because they may cause malfunction of outdoor unit.
- ▶ Maintain sufficient clearance around the outdoor unit, especially from a radio, computer, stereo system, etc.

Installation Guide at the seashore

Make sure to follow below guides when installing at the seashore.

1. Do not install the product in a place where it is directly exposed to sea water and sea breeze.
 - Make sure to install the product behind a structure (such as building) that can block sea breeze.
 - Even when it is inevitable to install the product in seashore, make sure that product is not directly exposed to sea breeze by installing a protection wall.
 2. Consider that the salinity particles clinging to the external panels should be sufficiently washed out.
 3. Because the residual water at the bottom of the outdoor unit significantly promotes corrosion, make sure that the slope does not disturb drainage.
 - Keep the floor level so that rain does not accumulate.
 - Be careful not to block the drain hole due to foreign substance
 4. When product is installed in seashore, periodically clean it with water to remove attached salinity.
 5. Make sure to install the product in a place that provides smooth water drainage. Especially, ensure that the base part has good drainage.
 6. If the product is damaged during the installation or maintenance, make sure to repair it.
 7. Check the condition of the product periodically.
 - Check the installation site every 3 months and perform anti-corrosion treatment such as R-Pro supplied by SAMSUNG (Code : MOK-220SA) or commercial water repellent grease and wax, etc., based on the product condition.
 - When the product is to be shut down for a long period of time, such as off-peak hours, take appropriate measures like covering the product.
 8. If the product installed within 500m of seashore, special anti-corrosion treatment is required.
- * Please contact your local SAMSUNG representative for further details.

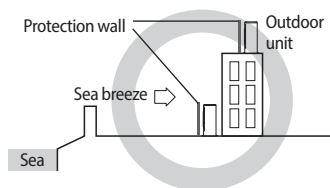
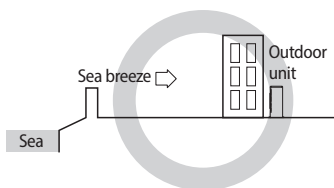
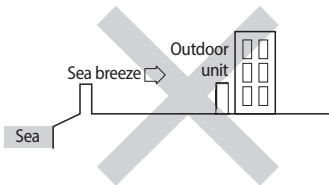

Protection wall should be constructed with a solid material that can block the sea breeze and the height and width of the wall should be 1.5 times larger than the size of the outdoor unit. (You must secure more than 700mm of space between the protection wall and the outdoor unit for air circulation.)



• Depending on the condition of power supply, unstable power or voltage may cause malfunction of the parts or control system. (At the ship or places using power supply from electric generator, etc).

- ▶ Do not install the Air to Water Heat Pump in following places.
 - The place where there is mineral oil or arsenic acid. There is a chance that parts may get damaged due to burned resin. The capacity of the heat exchanger may reduce or the Air to Water Heat pump may be out of order.
 - The place where corrosive gas such as sulfurous acid gas generates from the vent pipe or air outlet. The copper pipe or connection pipe may corrode and refrigerant may leak.
 - The place where there is a danger of existing combustible gas, carbon fiber or flammable dust. The place where thinner or gasoline is handled.



• This device must be installed according to the national electrical rules.
• With an outdoor unit having net weight upper than 60 kg, we suggest do not install it suspended on wall, but considering floor standing one.

4. Installation

Outdoor unit

- ▶ If the outdoor unit is installed at a height, ensure that its base is firmly fixed in position.
- ▶ Make sure that the water dripping from the drain hose runs away correctly and safely.
- ▶ When you install the outdoor unit at wayside, you should install it above 2 m height or make sure that the heat from the outdoor unit shouldn't be in direct contact with passersby. (The ground for application :The revision of regulation for facility in building by the law of the Ministry of Construction and Transportation.

Moving the Outdoor Unit by Wire Rope

Fasten the outdoor unit by two 8 m or longer wire ropes as shown at the figure. To prevent from damage or scratches, insert a piece of cloth between the outdoor unit and rope, then move the unit.

- * The appearance of the unit may be different from the picture depending on the model.

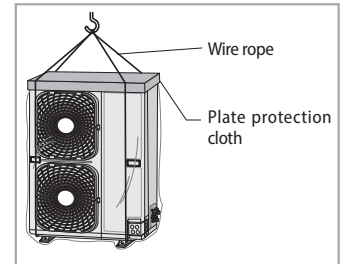

Space requirements for outdoor unit

When installing 1 outdoor unit

(Unit : mm)

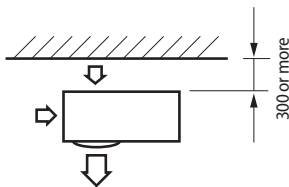

- * When the air outlet is opposite the wall

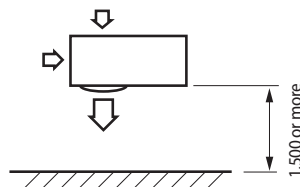

- * When the air outlet is towards the wall

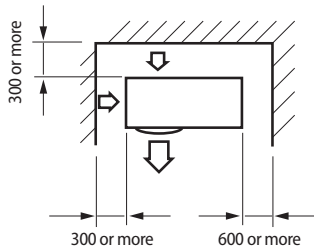

- * When 3 sides of the outdoor unit are blocked by the wall

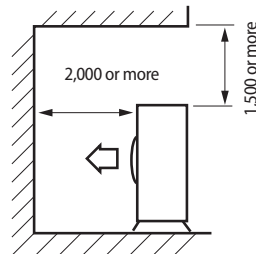

- * The upper part of the outdoor unit and the air outlet is towards the wall

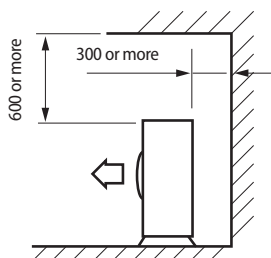

- * The upper part of the outdoor unit and the air outlet is opposite the wall

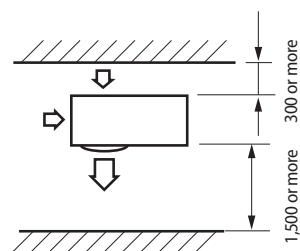

- * When front and rear side of the outdoor unit is towards the wall

4. Installation

Outdoor unit

When installing more than 1 outdoor unit

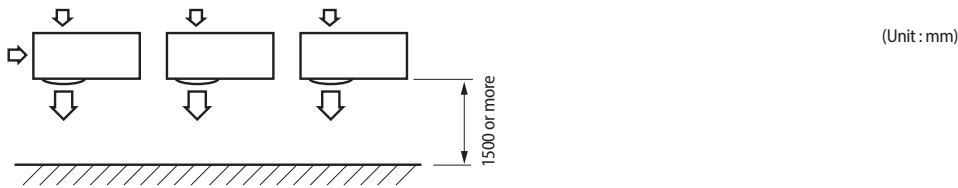

* When the air outlet is towards the wall

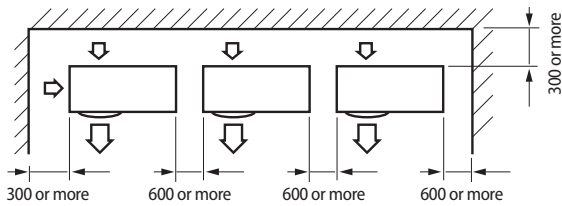

* When 3 sides of the outdoor unit are blocked by the wall

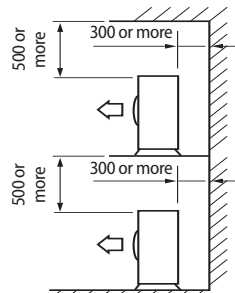
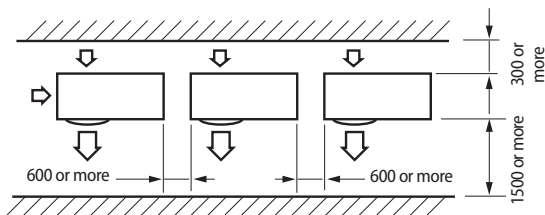

* When front and rear side of the outdoor unit is towards the wall

* The upper part of the outdoor unit and the air outlet is opposite the wall

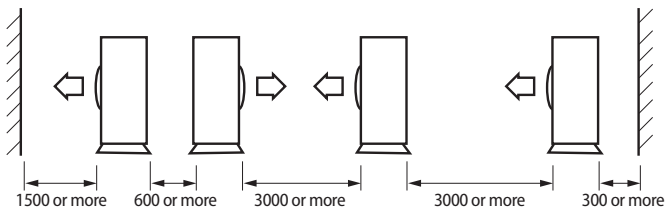

* When front and rear side of the outdoor unit is towards the wall

CAUTION • The units must be installed according to distances declared, in order to permit accessibility from each side, either to guarantee correct operation of maintenance or repairing products. The unit's parts must be reachable and removable completely under safety condition (for people or things).

Outdoor unit installation

The outdoor unit must be installed on a rigid and stable base to avoid any increase in the noise level and vibration, particularly if the outdoor unit is to be installed in a location exposed to strong winds or at a height, the unit must be fixed to an appropriate support (wall or ground).

- Fix the outdoor unit with anchor bolts.

NOTE • The anchor bolt must be 20 mm or higher from the base surface.

CAUTION • When tightening the anchor bolt, tighten the rubber washer to prevent the outdoor unit bolt connection part from corroding.
• Make a drain outlet around the base for outdoor unit drainage.
• If the outdoor unit is installed on the roof, you have to check the ceiling strength and waterproof the unit.

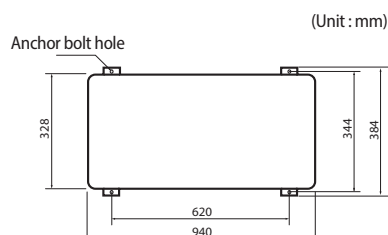

4. Installation

Outdoor unit

Electrical connections

Overall system configuration

Connection of the power cable (1 phase 2 wires)

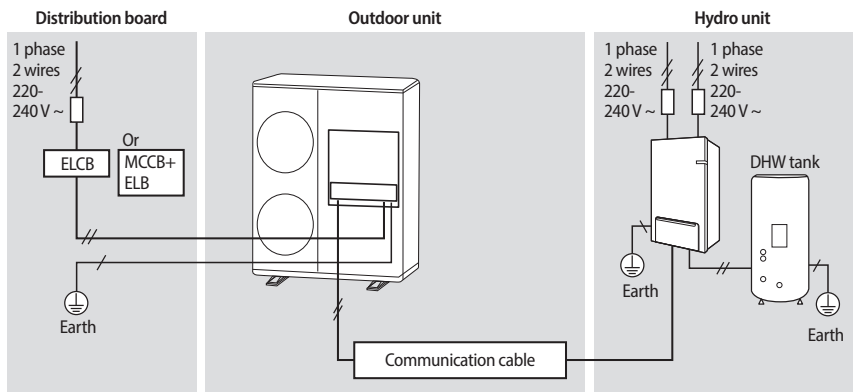

- Install cabinet panel near the outdoor unit for the convenience of service and emergency operation off.
- CAUTION**
- Make sure to install the circuit breaker with the over-current and electric leakage protection.

Connection of the power cable (3 phase 4 wires)

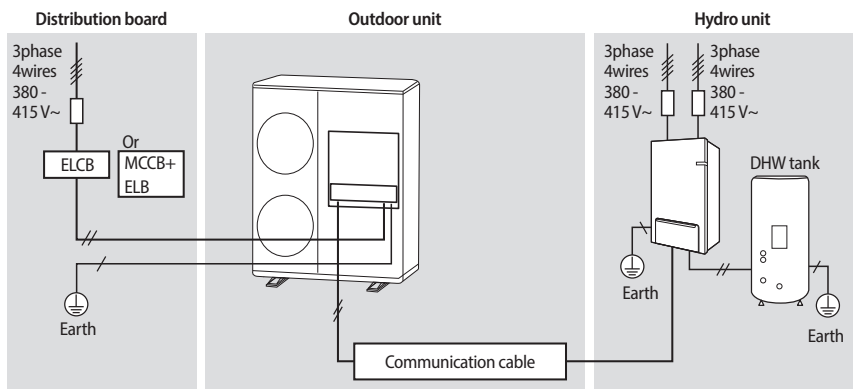

- Install cabinet panel near the outdoor unit for the convenience of service and emergency operation off.
- CAUTION**
- Make sure to install the circuit breaker with the over-current and electric leakage protection.

Connecting the cable

Power cable specifications

1 phase

Outdoor unit	Rated		Voltage Range		MCA	MFA
	Hz	Volts	Min	Max	Min. Circuit Amps.	Max. Fuse Amps.
AE120AXEDEH	50	220-240	198	264	28 A	35 A
AE160AXEDEH	50	220-240	198	264	32 A	40 A

- ▶ The power cable is not supplied with Air to Water Heat pump.
- ▶ Supply cords of parts of appliances for outdoor use shall not be lighter than polychloroprene sheathed flexible cord (Code designation IEC:60245 IEC 57 / CENELEC:H05RN-F)
- ▶ This Equipment complies with IEC 61000-3-12.

4. Installation

Outdoor unit

3 Phase

Outdoor unit	Rated		Voltage Range		MCA	MFA
	Hz	Volts	Min	Max	Min. Circuit Amps.	Max. Fuse Amps.
AE120AXEDGH	50	380-415	342	457	10 A	16.1 A
AE160AXEDGH	50	380-415	342	457	12 A	16.1 A

- ▶ The power cable is not supplied with Air to Water Heat pump.
- ▶ Supply cords of parts of appliances for outdoor use shall not be lighter than polychloroprene sheathed flexible cord (Code designation IEC:60245 IEC 66 / CENELEC:H07RN-F)
- ▶ This equipment complies with IEC 61000-3-12 provided that the short-circuit power S_{sc} is greater than or equal to 3.3[MVA] at the interface point between the user's supply and the public system. It is the responsibility of the installer or user of the equipment to ensure, by consultation with distribution network operator if necessary, that the equipment is connected only to a supply with a short-circuit power S_{sc} greater than or equal to 3.3[MVA].

Connecting the cable

Specification of connection cables (common in use)

Power supply	Max/Min(V)	Communication cable
1 Φ , 220-240 V, 50 Hz	$\pm 10\%$	0.75~1.5 mm ² , 2 wires
3 Φ , 380-415 V, 50 Hz		

- ▶ For Power Cable, use the grade H07RN-F or H05RN-F materials.

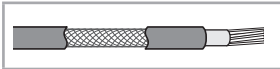

When installing the indoor unit, outdoor unit use the double shielded (Tape aluminum / polyester braid + copper) cable of FROHH2R type.

1-phase terminal block spec

AC power : M5 screw

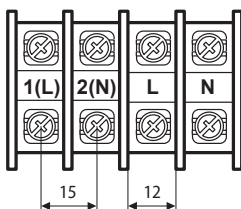

Communication : M4 screw

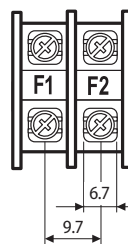

3-phase terminal block spec

AC power : M4 screw

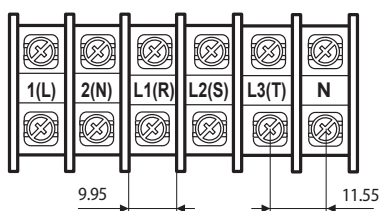

Communication : M4 screw

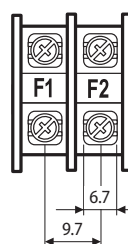

4. Installation

Outdoor unit

Wiring diagram of power cable

When using ELB for 1 phase and 3 phase

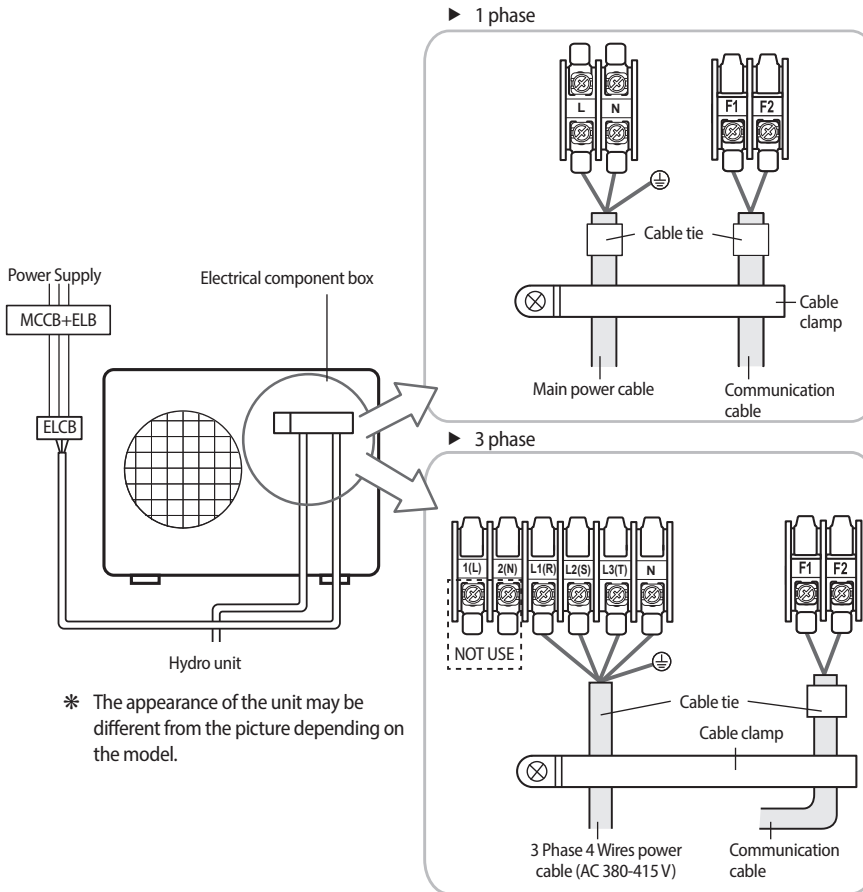

CAUTION

- You should connect the power cable into the power cable terminal and fasten it with a clamp.
- The unbalanced power must be maintained within 2 % of supply rating.
 - If the power is unbalanced greatly, it may shorten the life of the condenser. If the unbalanced power is exceeded over 4 % of supply rating, the indoor unit is protected, stopped and the error mode indicates.
- To protect the product from water and possible shock, you should keep the power cable and the connection cord of the indoor and outdoor units within ducts. (with appropriate IP rating and material selection for your application)
- Ensure that main supply connection is made through a switch that disconnects all poles, with contact gap of a least 3 mm.
- Devices disconnected from the power supply should be completely disconnected in the condition of overvoltage category.
- Keep distances of 50 mm or more between power cable and communication cable.

4. Installation

Outdoor unit

Connecting the cable

1 phase 2 wires

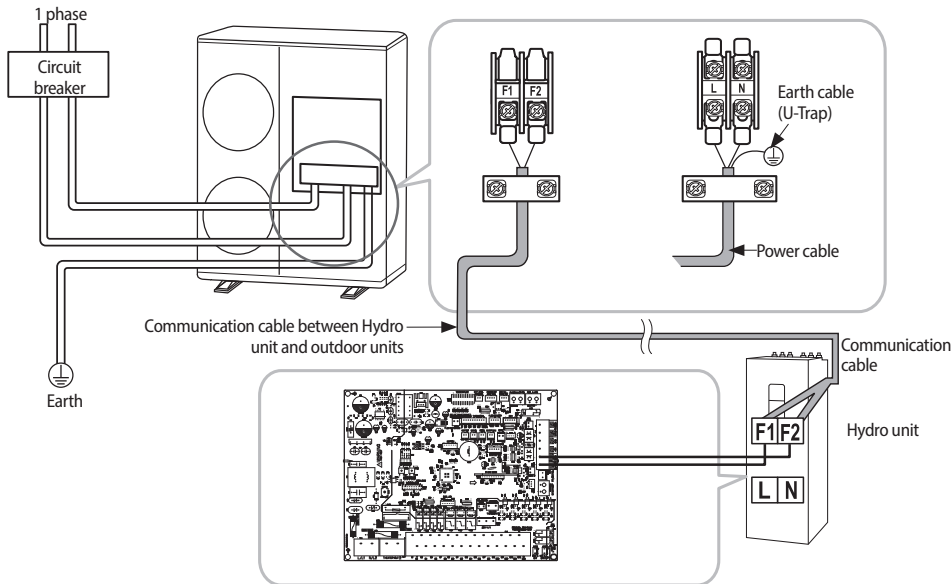

- When removing the outer cover of the power cable, use the appropriate tools to prevent damaging the inner cover.
- Make sure to place the outer cover of the power cable and the communication cable, at least 20 mm into the electrical parts.
- Communication wiring should be done separately from the power cable and other communication cables.

3 phase 4 wires

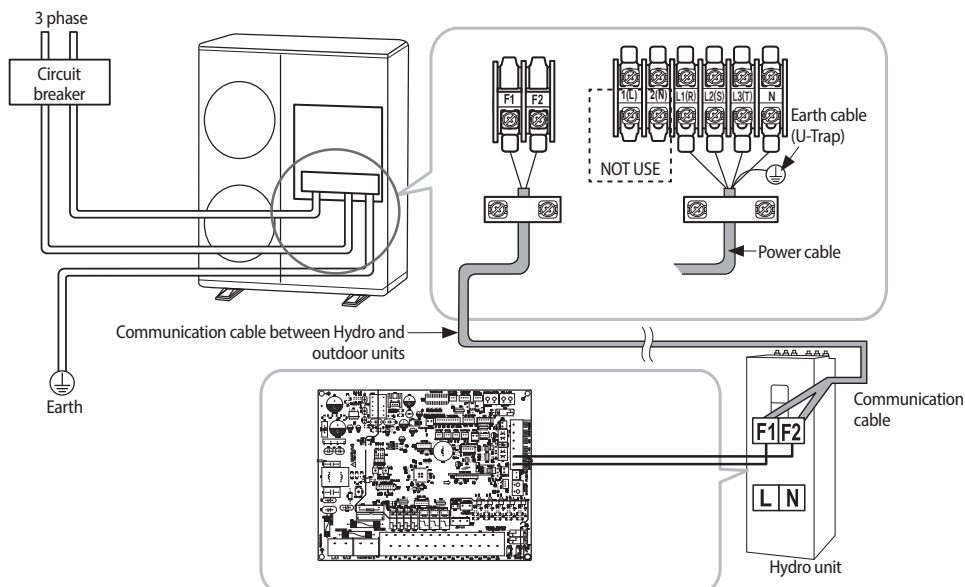

- When removing the outer cover of the power cable, use the appropriate tools to prevent damaging the inner cover.
- Make sure to place the outer cover of the power cable and the communication cable, at least 20 mm into the electrical parts.
- Communication wiring should be done separately from the power cable and other communication cables.

4. Installation

Outdoor unit

Connecting the power terminal

- ▶ Connect the cables to the terminal board using the compressed ring terminal.
- ▶ Connect the rated cables only.
- ▶ Connect using a wrench which is able to apply the rated torque to the screws.
- ▶ If the terminal is loose, fire may occur caused by arc. If the terminal is connected too firmly, the terminal may be damaged.

Tightening Torque (kgf.cm)	
M4	12~18
M5	20~30

Installing the earth wire

- ▶ Earthing must be done by your installation specialist for your safety.
- ▶ Use the earth wire by referring to the specification of the electric cable for the outdoor unit.

Earthing the power cable

- ▶ The standard of earthing may vary according to the rated voltage and installation place of the Air to Water Heat Pump.
- ▶ Earth the power cable according to the following.

Power condition	Installation place		
	High humidity	Average humidity	Low humidity
Electrical potential of lower than 150 V		Perform the earthing work 3. ^{Note 1)}	Perform the earthing work 3 if possible for your safety. ^{Note 1)}
Electrical potential of higher than 150 V		Must perform the earthing work 3. ^{Note 1)} (In case of installing circuit breaker)	

* Note 1) Earthing work 3

- Earthing must be done by your installation specialist.
- Check if the earthing resistance is lower than 100Ω. When installing a circuit breaker that can cut the electric circuit in case of a short circuit, the allowable earthing resistance can be 30~500Ω.

- ▶ When using the terminal for earthing only

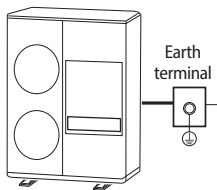

- ▶ When using earthing of the switchboard

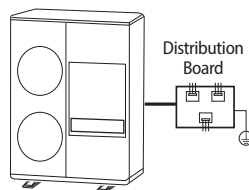

Refrigerant piping work

- ▶ Install the refrigerant pipe within the maximum allowable length, difference in height and length of after the first branch pipe.
- ▶ The pressure of the R-410A is high.
Use only rated refrigerant pipe and follow the installation method.
- ▶ Use clean refrigerant pipe Where there is no harmful ion, oxide, dust, iron content or moisture.
- ▶ Use adequate tools and accessories for R-410A.

Manifold gauge	<ul style="list-style-type: none"> • Use manifold gauge only for R-410A to prevent the inflow of foreign substances.
Vacuum pump	<ul style="list-style-type: none"> • Use vacuum pump with check valve to prevent pump oil from flowing backward while the vacuum pump is stopped. • Use the vacuum pump that the vacuum induction is available up to 5Torr. (-100.7kPa)
Flare nut	<ul style="list-style-type: none"> • Use only flare nut supplied with the product.

4. Installation

Outdoor unit

Allowable length of the refrigerant pipe and the installation examples

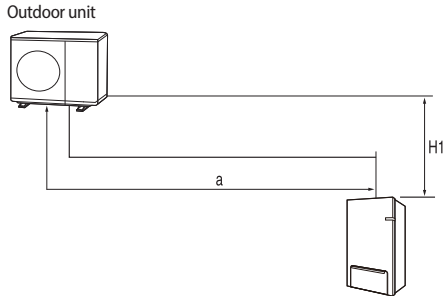

Item			Example	Remarks
Maximum allowable length of pipe	Outdoor unit ~ Hydro unit	Total length	Less than 50 m	$a \leq 50$ m
Maximum allowable height	Outdoor unit ~ Hydro unit	Less than 30 m		H1 If outdoor unit is located lower position H1 ≤ 15 m
Additional refrigerant calculation		R=Basic charge + additional charge by the piping length		

Contact the manufacturer if the length should exceed.

Selecting the refrigerant pipe

Outdoor unit capacity (kW)	Liquid side (mm)	Gas side (mm)
AE120AXEDEH	ø9.52	ø15.88
AE120AXEDGH		
AE160AXEDEH		
AE160AXEDGH		

- ▶ Install refrigerant pipe depending on the outdoor unit capacity.
- ▶ Make sure to use C1220T-1/2H (Semi-hard) pipe for more than ø19.05 mm. In case of using C1220T-O (Soft) pipe for ø19.05 mm, pipe may be broken, which can result in an injury.

Outer diameter (mm)	Minimum thickness (mm)	Temper grade
ø6.35	0.7	C1220T-O
ø9.52	0.7	
ø12.70	0.8	
ø15.88	1.0	
ø15.88	0.8	C1220T-1/2H OR C1220T-H
ø19.05	0.9	
ø22.23	0.9	

* Temper grade and minimum thickness of the refrigerant pipe

Refrigerant piping work

Selecting the insulator of the refrigerant pipe

- ▶ According to pipes size, insulate pipes on gas and liquid side by selecting appropriate insulations.
- ▶ Standard condition is under a temperature of 30 °C and a humidity of 85 %. If the units are installed in extreme weather conditions, select the insulator by table below.

Pipe type	Pipe diameter (mm)	Thickness of insulator		Remarks
		Normal (Under 30 °C, 85 %)	High humidity (Over 30 °C, 85 %)	
		EPDM, NBR		
Liquid	ø6.35~ø19.05	9	9	The material shall has heat resistant over 120 °C
	ø12.70~ø19.05	13	13	
Gas	ø6.35	19	19	
	ø9.52		25	
	ø12.70			
	ø15.88			
	ø19.05			



- Install the insulation not to be get wider and use the adhesives on the connection part of it to prevent moisture entering.
- Wind the refrigerant pipe with insulation tape if it is exposed to outside sunlight.
- Install the refrigerant pipe respecting that the insulation does not get thinner on the bent part or hanger of pipe.

4. Installation

Outdoor unit

Selecting additional refrigerant charge

* Basic charge

The basic amount of refrigerant for outdoor unit charged in factory is:

Outdoor unit (Series)	Factory charge(kg)
AE120AXEDEH	2.98
AE120AXEDGH	
AE160AXEDEH	
AE160AXEDGH	

- * Charge additional refrigerant according to the total length of the pipe.
Each factory charging values are determined according to basic pipe length 15 m.
When extra pipe length are required, additional charging works must be implemented as describes below.

Refrigerant Charging

- * Additional charging amount is determined based on liquid pipe specifications.

Outdoor unit of liquid	ø9.52
Additional charging (g)	50 g/m

$$\text{Additional Charge(g)} = (L-15) \times 50$$



- L1: Total length of liquid pipe ø 9.52(m)_Model : **120/160**

Ex) Total length of liquid pipe =20 m
 $\Phi 9.52 = (20\text{m}-15\text{m}) \times 50\text{g/m} = 250 \text{ g}$ (Model : **120/160**)

Charging refrigerant

- ▶ The R-410A refrigerant is blended refrigerant. Add only liquid refrigerant.
- ▶ Measure the quantity of the refrigerant according to the length of the liquid side pipe. Add quantity of the refrigerant using a scale.

Important information: regulation regarding the refrigerant used

This product contains fluorinated greenhouse gases. Do not vent gases into the atmosphere.



- Inform user if the system contains 5 tCO₂e or more of fluorinated greenhouse gases. In this case, it must be checked for leakage at least once every 12 months, according to regulation No. 517/2014. This activity must be covered by qualified personnel only. In the case of the situation above, the installer (or authorized person with responsibility for final check) must provide a maintenance book, with all the information recorded, according to REGULATION (EU) No. 517/2014 OF THE EUROPEAN PARLIAMENT AND OF THE COUNCIL of 16 April 2014 on fluorinated greenhouse gases.

Please fill in the following indelible ink on the refrigerant charge label supplied with this product on and on this manual.

- ▶ ① The factory refrigerant charge of the product.
- ▶ ② The additional refrigerant amount charged in the field.
- ▶ ①+② The total refrigerant charge.



- Factory refrigerant charge of the product: See unit name plate.
- Additional refrigerant amount charged in the field. (Refer to the above information for the quantity of refrigerant replenishment.)
- Total refrigerant charge.
- Refrigerant cylinder and manifold for charging.

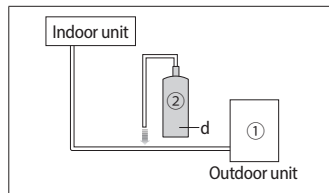

Unit	kg	tCO ₂ e
①, a		
②, b		
① + ②, c		

Refrigerant type	GWP value
R-410A	2088

- * GWP: Global Warming Potential
- * Calculating tCO₂e: kg x GWP/1000

4. Installation

Outdoor unit

- ▶ Before charging, check whether the refrigerant cylinder has a siphon attached or not and position the cylinder accordingly.

Charging using a cylinder with a siphon attached

Charge the liquid refrigerant with the cylinder in upright position.

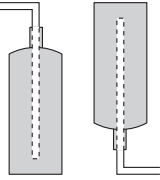

Charging using a cylinder without a siphon attached

Charge the liquid refrigerant with the cylinder in up-side-down position.

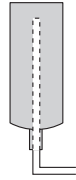

Adding refrigerant

- ▶ The R-410A refrigerant is blended refrigerant. Add only liquid refrigerant.
- ▶ Measure the quantity of the refrigerant depending on the length of the liquid side pipe. Add fixed quantity of the refrigerant using a scale.

* Adding refrigerants in cooling conditions

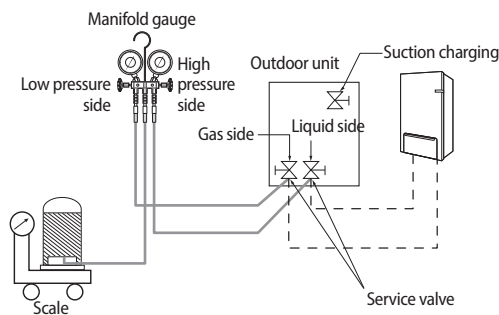

* Adding refrigerants in heating conditions

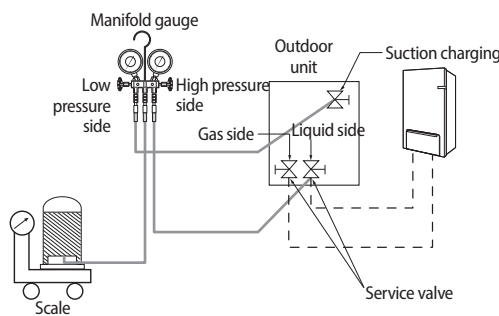

- ▶ Connect the manifold gauge and purge the manifold gauge.
- ▶ Open the manifold gauge valve of the liquid side service valve and add the liquid refrigerant.
- ▶ If you cannot fully recharge the additional refrigerant while the outdoor unit is stopped, use the key on the outdoor unit PCB to recharge the remaining refrigerant.
- ▶ Adding the cooling refrigerant
 - 1) Press the function key for adding refrigerant in cooling mode.
 - 2) After 20 minutes of operation, open the valve on gas side.
 - 3) Open the valve for low pressure side on the manifold gauge to recharge the remaining refrigerant.
- ▶ Adding the heating refrigerant
 - 1) When recharging the heating refrigerant, connect the low pressure pipe from manifold gauge to the suction charging port.
 - 2) Press the function key for adding refrigerant in heating mode.
 - 3) After 20 minutes of operation, open the valve on suction charge port.
 - 4) Open the valve for low pressure side on the manifold gauge to recharge the remaining refrigerant.



• Open the gas side and liquid side service valve completely after charging the refrigerant. (If you operate the Air to Water Heat Pump with the service valve closed, the important parts may be damaged.)

2021.04
Ver.1.1

Samsung Electronics Co., LTD.

Head Office (Suwon Korea) 129, Samsung-Ro, Yeongtong-Gu, Suwon City, Gyeonggi-Do, Korea 16677
Website : www.samsung.com, <https://partnerhub.samsung.com> Email : airconditioner@samsung.com
Images and data in this book may subject to change without prior notice.